



ALLESTIMENTI VEICOLI COMMERCIALI
AMÉNAGEMENTS DE VÉHICULES UTILITAIRES



FIAT DOBLÒ





Store Van è l'unico produttore al mondo di allestimenti per veicoli commerciali ad utilizzare questa tecnologia.

StoreVan est le seul fabricant d'aménagements de véhicules utilitaires au monde à utiliser cette technologie.

TECNOLOGIE

ACCIAIO GALVANNEALED

La lamiera galvannealed è una variante della lamiera zincata a caldo. Il prodotto subisce un processo di zincatura a caldo e un successivo riscaldamento ad una temperatura di ca. 550°C attraverso il quale lo zinco si salda alla superficie della lamiera formando una lega con l'acciaio.

Il risultato che si ottiene è uno strato zincato uniforme e dalla struttura cristallina fine abbinati ad una **qualità della superficie e una resistenza alla corrosione nettamente superiori**. Questo processo è ideale per le applicazioni automotive. Store Van ha introdotto e implementato tale tecnologia anche nel settore dell'allestimento veicoli industriali.

VERNICIATURA PER IMMERSIONE - CATODICA - CON RESINA ACRILICA

La verniciatura per cataforesi è un trattamento superficiale di verniciatura in grado di conferire agli elementi dell'allestimento una **notevole resistenza alla corrosione**; è caratterizzata dal **deposito uniforme** di una resina acrilica sulla superficie dell'elemento, assicurando per lungo tempo un'elevata protezione nei confronti degli agenti chimici e di altri tipi di attacchi. La resina acrilica consente una diretta esposizione agli agenti atmosferici mantenendo inalterate le caratteristiche tecniche. Con questo processo si assicura una maggiore protezione dalla ruggine.

- Resistenza alla corrosione superiore a 500 ore (umidità ASTM D1735)
- Eccellente durezza con valutazione minima 2H



STORE VAN ORANGE PLANET

Sostenibilità ambientale e sviluppo eco-compatibile sono temi di rilevante attualità ed interesse, sorti dalla crescente consapevolezza che si debba prestare attenzione all'equilibrio ambientale.

STORE VAN ORANGE PLANET

La durabilité environnementale et le développement éco-compatibile sont des sujets importants d'actualité et d'intérêt, découlés d'une prise de conscience croissante qu'on doit prêter attention à l'équilibre environnemental.

TECHNOLOGIES

ACIER GALVANNEALED

La tôle galvannealed est une variante de la tôle galvanisée à chaud. Le produit est soumis à un procédé de galvanisation à chaud, puis de chauffage à une température d'env. 550 °C par lequel le zinc se soude à la surface de la tôle en formant un alliage avec l'acier.

Le résultat obtenu est une couche de zinc uniforme et une structure cristalline fine combinées à **une qualité de la surface et une résistance à la corrosion nettement plus élevées**. Ce procédé est idéal pour les applications au sein du secteur automobile. StoreVan a introduit et optimisé cette technologie également dans le domaine des aménagements de véhicules utilitaires.

PEINTURE PAR IMMERSION - CATHODIQUE - AVEC RESINE ACRYLIQUE

La peinture cathodique est un traitement de surface qui permet de conférer aux éléments de l'aménagement **une résistance remarquable à la corrosion** ; elle est caractérisée par le **dépôt uniforme** d'une résine acrylique sur la surface de l'élément, en garantissant une haute et durable protection contre les agents chimiques et d'autres types d'agressions. La résine acrylique permet une exposition directe aux agents atmosphériques, tout en conservant inchangées les caractéristiques techniques. Ce procédé garantit aussi une meilleure protection contre la rouille.

- Résistance à la corrosion supérieure à 500 heures (humidité ASTM D1735)
- Excellente dureté avec une évaluation minimale 2H



FISSAGGIO FLESSIBILE FIXATION FLEXIBLE

FLESSIBILITÀ E DUREVOLEZZA DEGLI ALLESTIMENTI PER FURGONI STORE VAN
Store Van utilizza uno speciale sistema a binario per il fissaggio delle scaffalature per furgoni allo chassis del veicolo commerciale, conferendo una grande flessibilità al posizionamento dei moduli e massimizzando l'utilizzo degli spazi interni al furgone attrezzato.

Il sistema prevede l'utilizzo di staffe che scorrono all'interno del binario in tutta la sua lunghezza anziché esser rivettate direttamente ai rinforzi dello chassis, che obbligano, nella progettazione dell'allestimento furgone, a una sostanziale rigidità nella gestione degli spazi. Il binario usato da Store Van viene fissato ai montanti verticali dell'officina mobile, con la doppia funzione di collegare in maniera uniforme gli scaffali per furgoni al telaio del veicolo e di distribuire omogeneamente tutte le forze dinamiche a cui l'allestimento viene sottoposto durante la guida.

Le staffe di fissaggio che collegano il binario al modulo presentano uno speciale snodo che ammortizza le vibrazioni derivanti dalla guida del veicolo, adattandosi ai movimenti torsionali dello chassis, specialmente in percorrenza di curve.

Grazie a questo sistema, i nostri allestimenti per furgoni possono essere progettati con la massima libertà, garantendo comunque alti standard di sicurezza, stabilità e durevolezza nel tempo.

Tutti i nostri sistemi di fissaggio si possono avvalere di sistemi di aggancio/sgancio rapido dei moduli tramite maniglie a ripresa che permettono di smontare l'allestimento senza l'ausilio di utensili. In questo modo la scaffalatura della tua officina mobile può essere dichiarata come materiale trasportato o come ausilio alla sicurezza del carico non permanentemente fissato al veicolo, come descritto nella DIRETTIVA 2014/47 UE, CAPO 1, Articolo 3, paragrafo 5.

FLEXIBILITÉ ET DURÉE DES AMÉNAGEMENTS POUR FOURGONS STORE VAN

Store Van utilise un système à rail spécial pour la fixation des rayonnages pour fourgons au châssis du véhicule utilitaire : cela garantit une grande flexibilité pour le positionnement des modules et optimise l'utilisation des espaces à l'intérieur du fourgon aménagé.

Le système prévoit l'utilisation d'étriers qui coulissent à l'intérieur du rail sur toute sa longueur au lieu d'être rivetés directement aux renforts du châssis, ce qui impose, dans la conception de l'aménagement du fourgon, une grande rigueur dans la gestion des espaces. Le rail utilisé par Store Van, fixé aux montants verticaux de l'atelier mobile, a une double fonction : solidariser de manière uniforme les rayonnages pour fourgons au châssis du véhicule et distribuer de manière homogène toutes les forces dynamiques auxquelles l'aménagement est soumis durant les déplacements.

Les étriers de fixation qui relient le rail au module présentent un dispositif articulé spécial qui amortit les vibrations causées par le déplacement du véhicule, en s'adaptant aux mouvements de torsion du châssis, en particulier dans les virages.

Grâce à ce système, nos aménagements pour fourgons peuvent être conçus avec la plus grande liberté, mais dans le respect de standards de sécurité, de stabilité et de durée élevés.

Tous nos systèmes de fixation peuvent bénéficier de systèmes d'accrochage/déaccrochage rapide des modules au moyen de poignées de serrage à cliquet qui permettent de démonter l'aménagement sans utiliser d'outils. Le rayonnage de votre atelier mobile peut ainsi être déclaré comme matériel transporté ou comme dispositif de sécurité du chargement fixé au véhicule de manière non permanente, conformément aux dispositions de la directive 2014/47 UE, chapitre 1, article 3, paragraphe 5.



CERTIFICAZIONI

CERTIFICATIONS

PRODUZIONE CERTIFICATA

- Certificati ISO 9001:2015.
- Superata brillantemente la prova di CRASH TEST eseguita secondo le ultime normative europee ECE-R17 con impatto a 50 Km/h.
- Certificazione GS per l'arredo interno e le rampe di carico.
- Certificazione GS per il portatutto-portascale.

PRODUCTION CERTIFIÉE

- Certifiés ISO 9001:2015.
- ESSAI DE CHOC réalisé selon les normes européennes ECE-R17 les plus récentes avec impact à 50 km/h, passé brillamment.
- Certification GS pour l'aménagement interne et les rampes de chargement.
- Certification GS pour les galeries de toit et porte-échelles.

CRASH TEST
ECE-R17



La base per la protezione sicura dei veicoli

Base pour la protection des véhicules en toute sécurité

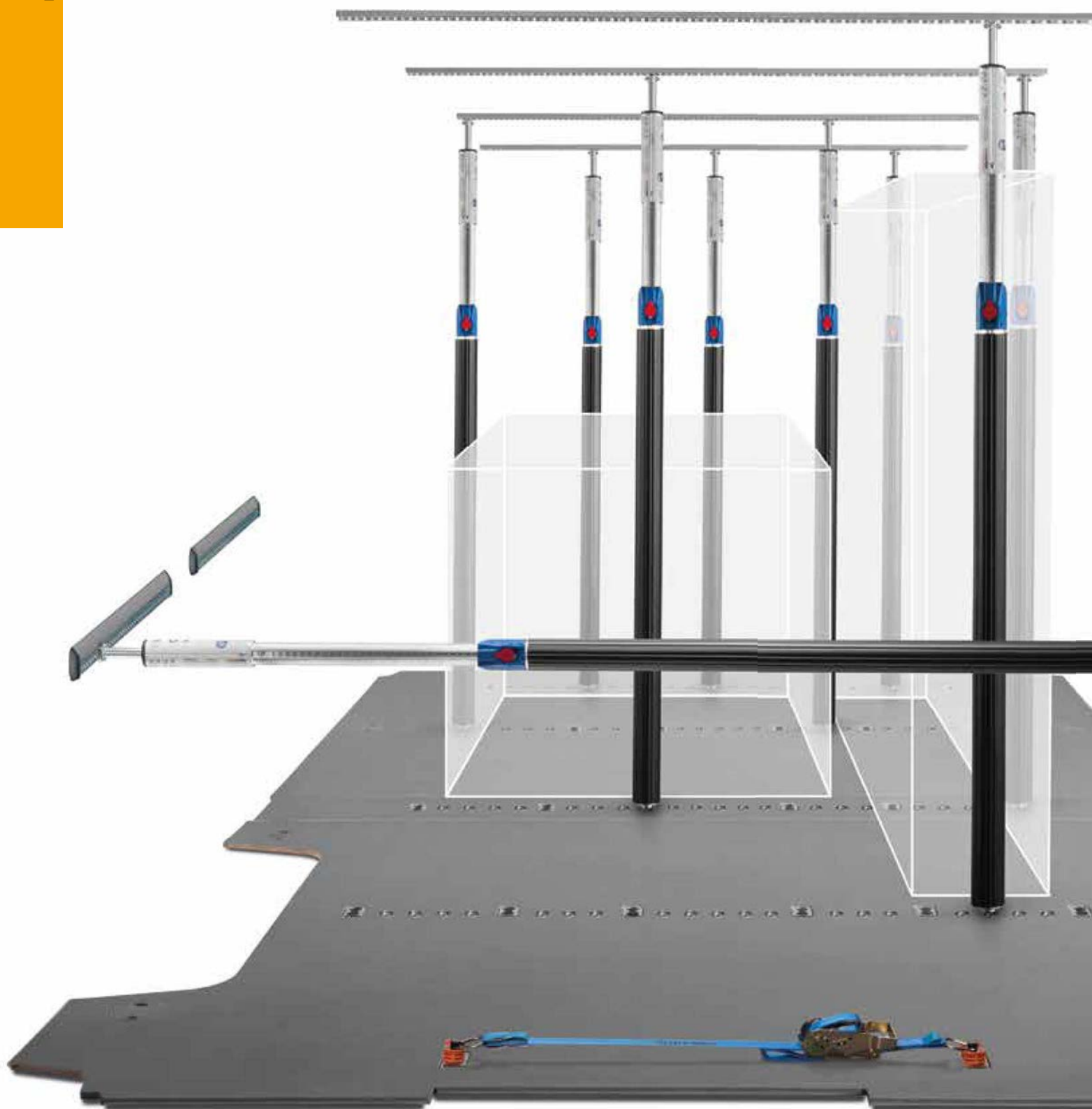

SICUREZZA DEL CARICO PER FURGONI E BLOCCAGGIO MERCE

Con il recepimento della direttiva 2014/47/EU verranno intensificati i controlli sui veicoli trasporto merci N2 e N3 e sensibilizzato il controllo del fissaggio del carico. La Direttiva consente agli Stati membri la possibilità di sottoporre a controlli tecnici veicoli che esulano dal suo ambito d'applicazione, come i veicoli commerciali della categoria N 1 e di controllare altri aspetti del trasporto e della sicurezza stradale.

SISTEMA DI PROTEZIONE DEL VANO DI CARICO E FISSAGGIO DEL CARICO

Il nuovo sistema di protezione integrato per furgoni ideato da Store Van segue le linee guida della nuova direttiva 2014/47/EU e consente il **fissaggio flessibile e sicuro** del carico ai pianali e alle pareti del veicolo.

Con l'impiego dei componenti di aggancio "Airline", e l'integrazione di numerosi accessori come cinghie, reti e pali telescopici, l'utilizzatore del veicolo può configurare la sua piattaforma di aggancio semplice, economica e a norma con la direttiva europea.

Il sistema prevede l'utilizzo di:

- pianali per furgoni in multistrato resina fenolica con predisposizione per gli ancoraggi originali del veicolo e ancoraggi supplementari (pag. 10) a filo pianale con trazione pari a 200 daN;
- barre in alluminio "Airline" ancorate allo chassis (pag. 11);
- pannellature in polipropilene ad alta flessibilità e resistenza per proteggere internamente la carrozzeria dagli urti accidentali (pag.8).

CON L'APPLICAZIONE DEL NUOVO KIT DI PROTEZIONE, SI PUÒ APPREZZARE UNA LUNGA SERIE DI VANTAGGI:

- l'utilizzatore del veicolo può già fissare il carico in sicurezza alle barre "Airline" tramite le cinghie di trattenuta.
- Il kit di fissaggio integrato prolunga la conservazione del buono stato della carrozzeria.
- Il sistema di protezione conferisce un valore aggiunto, qualità molto importante per il mercato del nuovo e fondamentale per quello dell'usato, solitamente compromesso da danneggiamenti.

SÉCURITÉ DU CHARGEMENT POUR LES FOURGONS ET BLOCAGE DE LA MARCHANDISE

Suite à la transposition de la directive 2014/47/EU, les contrôles sur les véhicules de transport de marchandises N2 et N3 s'intensifieront et le contrôle de la fixation du chargement fera l'objet d'une attention accrue. La directive offre aux États membres la possibilité de soumettre à des contrôles techniques les véhicules qui échappent à son champ d'application, comme les véhicules utilitaires de la catégorie N 1, et de contrôler d'autres aspects du transport et de la sécurité routière.

SYSTÈME DE PROTECTION DE L'ESPACE DE CHARGEMENT ET DE FIXATION DU CHARGEMENT

Le nouveau système de protection intégré pour fourgons conçu par Store Van respecte les lignes directrices de la nouvelle directive 2014/47/EU et garantit une **fixation flexible et sûre** du chargement aux planchers et aux parois du véhicule.

En utilisant les composants d'accrochage « Airline » et grâce à l'adoption de nombreux accessoires tels que des sangles, des filets et des barres télescopiques, l'utilisateur du véhicule peut aménager sa plateforme d'accrochage de manière simple, économique et conforme à la directive européenne.

Le système prévoit l'utilisation:

- de planchers pour fourgons en multiplis avec résine phénolique prééquipés pour les arrimages d'origine du véhicule et les arrimages supplémentaires (page 10) au ras du plancher avec une traction de 200 daN ;
- de barres en aluminium « Airline » fixées au chassis (page 11) ;
- de panneaux en polypropylène très flexibles et résistants pour protéger l'intérieur de la carrosserie contre les chocs accidentels (page 8).

L'APPLICATION DU NOUVEAU KIT DE PROTECTION GARANTIT TOUTE UNE SÉRIE D'AVANTAGES:

- l'utilisateur du véhicule peut déjà fixer, de manière sûre, le chargement aux barres « Airline », grâce aux sangles d'arrimage;
- le kit de fixation intégré permet de conserver la carrosserie en bon état plus longtemps ;
- le système de protection confère au véhicule de la valeur ajoutée, une qualité très importante sur le marché du neuf et fondamentale pour celui de l'occasion, généralement mis à mal par les fréquents dommages.

SAFETY CROSS: punti di fissaggio longitudinali e trasversali su richiesta
SAFETY CROSS: points de fixation longitudinaux et transversaux sur demande

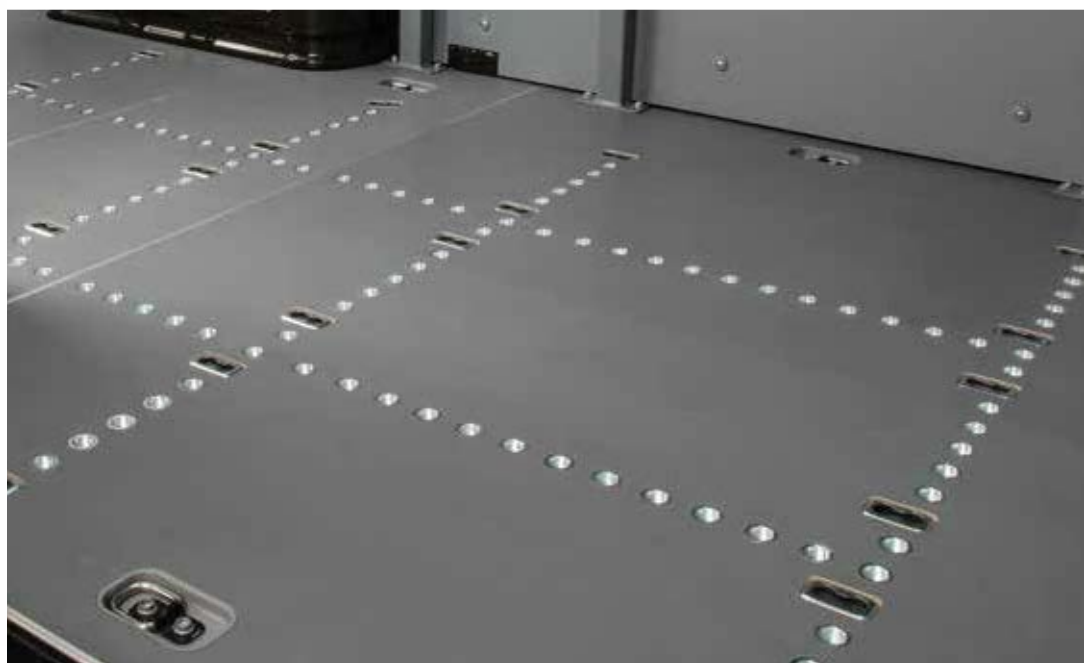

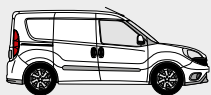

- Pannellature per veicolo con porta laterale destra e pareti lamierate.
- Habillages pour véhicule avec porte latérale droite et parois en tôle.



HONEYCOMB PANEL - A

- Pannellatura in polipropilene per:
 - parete laterale sinistra
 - parete laterale destra e porta scorrevole
- Habillage en polypropylène pour:
 - paroi latérale gauche
 - paroi latérale droite et porte coulissante

HONEYCOMB PANEL - C

- Pannellatura in polipropilene per:
 - parte superiore delle porte posteriori a battente
- Habillage en polypropylène pour :
 - partie supérieure des portes arrière battantes

VEICOLO VÉHICULE	PANNELLATURA HABILLAGE	
	A ART.	C ART.
Modello - Modèle L1 H1	DO 10H1 A0 3,11 kg	DO DRH1 A0 1,20 kg
Modello - Modèle L1 H2	DO 10H1 A0 3,11 kg	DO DRH2 A0 1,61 kg
Modello - Modèle L2 H1	DO 20H1 A0 4,63 kg	DO DRH1 A0 1,20 kg
Modello - Modèle L2 H2	DO 20H1 A0 4,63 kg	DO DRH2 A0 1,61 kg



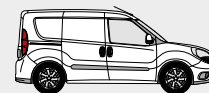

- Pianale per veicolo con porta laterale destra e pareti lamierate.
- Plancher pour véhicule avec porte latérale droite et parois en tôle.

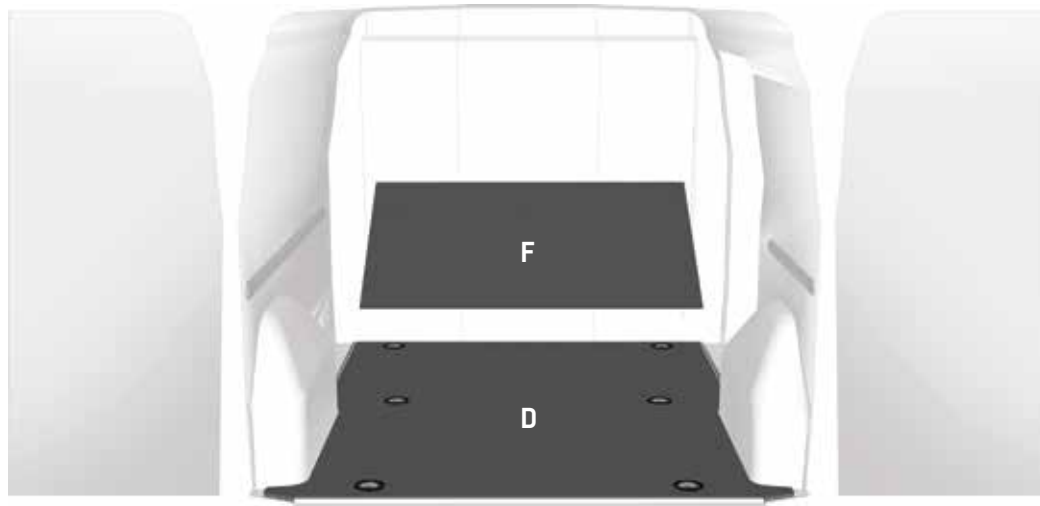

WOOD FLOOR - D

- Pianale in legno spessore 9 mm con rivestimento fenolico e predisposizione per gli ancoraggi originali del veicolo
- Plancher en bois de 9 mm avec revêtement phénolique et équipé pour les ancrages originaux du véhicule

WOOD FLOOR - F

- Pannello retrocabina in legno spessore 12 mm con rivestimento fenolico
- Panneau arrière cabine en bois de 12 mm d'épaisseur avec revêtement phénolique

FURGONE LAMIERATO - FOURGON TÔLE
FIAT DOBLÒ

WF

VEICOLO VÉHICULE	PIANALE 9 mm PLANCHER 9 mm	RETROCABINA ARRIÈRE CABINE
	D	F [1275x430x12 mm]
	ART.	ART.
Modello - Modèle L1 ^A	DO 10D1 BO 14,70 kg	DO WBT1 BO 4,24 kg
Modello - Modèle L1 ^B	DO 10D2 BO 14,50 kg	
Modello - Modèle L2 ^A	DO 20D1 BO 17,70 kg	DO WBT1 BO 4,24 kg
Modello - Modèle L2 ^B	DO 20D2 BO 17,47 kg	



^A Paratia in lamiera - Panneau de séparation tôle
^B Paratia in rete con cancelletto - Panneau de séparation grillagé avec portillon



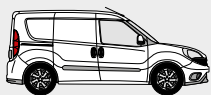

- Pianale per veicolo con porta laterale destra e pareti lamierate.
- Plancher pour véhicule avec porte latérale droite et parois en tôle.

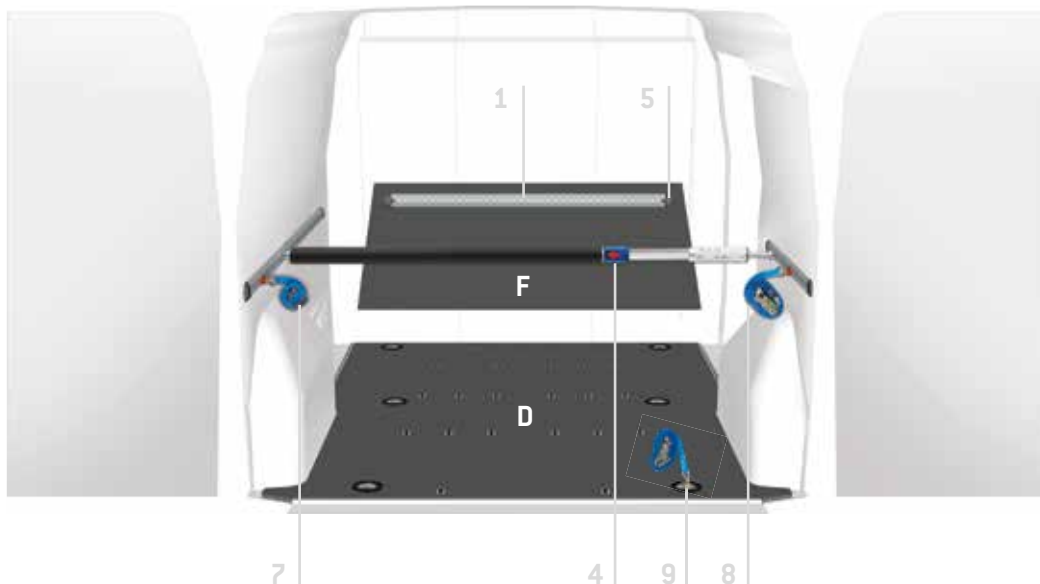
**SAFETY FLOOR - D**

- Pianale in legno spessore 9 mm con rivestimento fenolico e sistema di ancoraggio aggiuntivo
- Plancher 9 mm en bois avec revêtement phénolique et points d'ancrage supplémentaires

WOOD FLOOR - F

- Pannello retrocabina in legno spessore 12 mm con rivestimento fenolico
- Panneau arrière cabine en bois de 12 mm d'épaisseur avec revêtement phénolique

VEICOLO VÉHICULE	PIANALE 9 mm PLANCHER 9 mm	RETROCABINA ARRIÈRE CABINE
	D	F (1275x430x12 mm)
	ART.	ART.
Modello - Modèle L1 ^A	DO 10K1 BO 16,61 kg	DO WBT1 BO 4,24 kg
Modello - Modèle L1 ^B	DO 10K2 BO 16,40 kg	
Modello - Modèle L2 ^A	DO 20K1 BO 20,16 kg	DO WBT1 BO 4,24 kg
Modello - Modèle L2 ^B	DO 20K2 BO 19,95 kg	

^A Paratia in lamiera - Panneau de séparation tôle

^B Paratia in rete con cancelletto - Panneau de séparation grillagé avec portillon

⚠ Il pianale deve essere incollato al veicolo
Le plancher doit être collé au véhicule



- Colla siliconica per pianali.
- Colle en silicone pour planchers.

ART. **V22585**



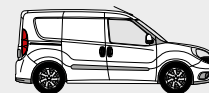

- Barra orizzontale in alluminio.
- Barre horizontale en aluminium.

1

ART.	V18029 05	Lunghezza - Longueur 500 mm
	V18029 10	Lunghezza - Longueur 1000 mm
	V18029 15	Lunghezza - Longueur 1500 mm
	V18029 20	Lunghezza - Longueur 2000 mm
	V18029 25	Lunghezza - Longueur 2500 mm



- Barra telescopica fermacarico.
- Barre télescopique d'arrimage.

4

ART.	V22149	Lunghezza - Longueur 650-900 mm
	V22734	Lunghezza - Longueur 850-1100 mm
	V22735	Lunghezza - Longueur 1050-1300 mm
	V22131	Lunghezza - Longueur 1250-1750 mm
	V22017	Lunghezza - Longueur 1550-2050 mm
	V22086	Lunghezza - Longueur 2000-2500 mm



- Finale in plastica per barra serie V18029.
- Bouchon en plastique pour barre série V18029.

5

ART.	V22106
------	--------



- Barra orizzontale in alluminio.
- Barre horizontale en aluminium.

2

ART.	V18025 05	Lunghezza - Longueur 500 mm
	V18025 10	Lunghezza - Longueur 1000 mm
	V18025 15	Lunghezza - Longueur 1500 mm
	V18025 20	Lunghezza - Longueur 2000 mm



- Anello fermacarico.
- Anneau d'arrimage.

6

ART.	V225820
------	---------



- Cinghia fermacarico con morsetto 2500+500.
- Sangle d'arrimage avec crochet 2500+500.

7



- Finale in plastica per barra serie V18025.
- Bouchon en plastique pour barre série V18025.

10

ART.	V23389
------	--------



- Cinghia fermacarico con cricchetto 2500+500.
- Sangle d'arrimage à cliquet 2500+500.

8

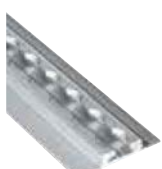

- Barra orizzontale in alluminio.
- Barre horizontale en aluminium.

3

ART.	V18030 10	Lunghezza - Longueur 1000 mm
	V18030 15	Lunghezza - Longueur 1500 mm
	V18030 20	Lunghezza - Longueur 2000 mm
	V18030 25	Lunghezza - Longueur 2500 mm
	V18030 30	Lunghezza - Longueur 3000 mm

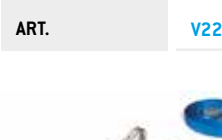

- Cinghia fermacarico con cricchetto 4500+500.
- Sangle d'arrimage à cliquet 4500+500.

9

<ul style="list-style-type: none"> • Esempio valigetta per il fissaggio del carico. • Exemple de mallette pour sécurisation du chargement. 	 1 ART. BOX080 L=440 P=350 H=80 mm	 2 ART. V22136
	 1 ART. CPV080	 2 ART. V22124
	 4 ART. V225820	 2 ART. V22148
	 1 ART. YELLOW	

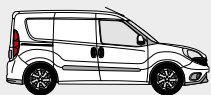

LEGENDA PANNELLATURE - LÉGENDE HABILLAGES

FIAT DOBLÒ

FURGONE LAMIERATO - FOURGON TÔLÉ

HP
HONEYCOMB
PANEL

- Per veicolo con porta laterale destra e pareti lamierate.
- Pour véhicule avec porte latérale droite et parois en tôle.

Modello - Modèle
L1 H1

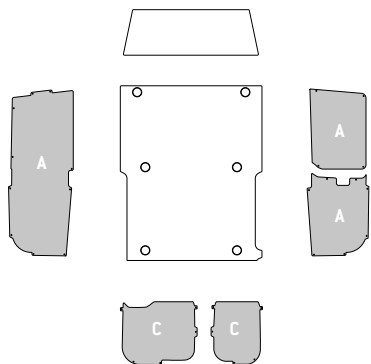

Modello - Modèle
L1 H2

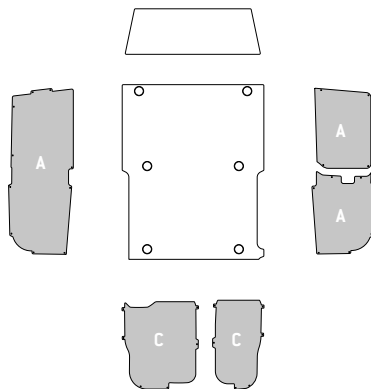

Modello - Modèle
L2 H1

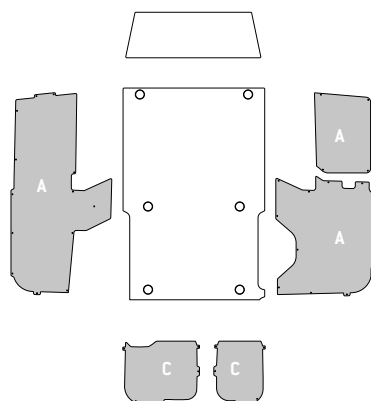

Modello - Modèle
L2 H2

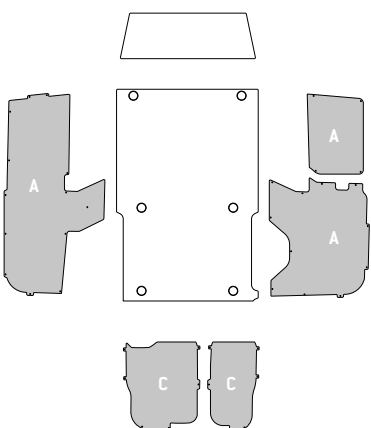

SAFETY CROSS: punti di fissaggio longitudinali e trasversali su richiesta
SAFETY CROSS: points de fixation longitudinaux et transversaux sur demande

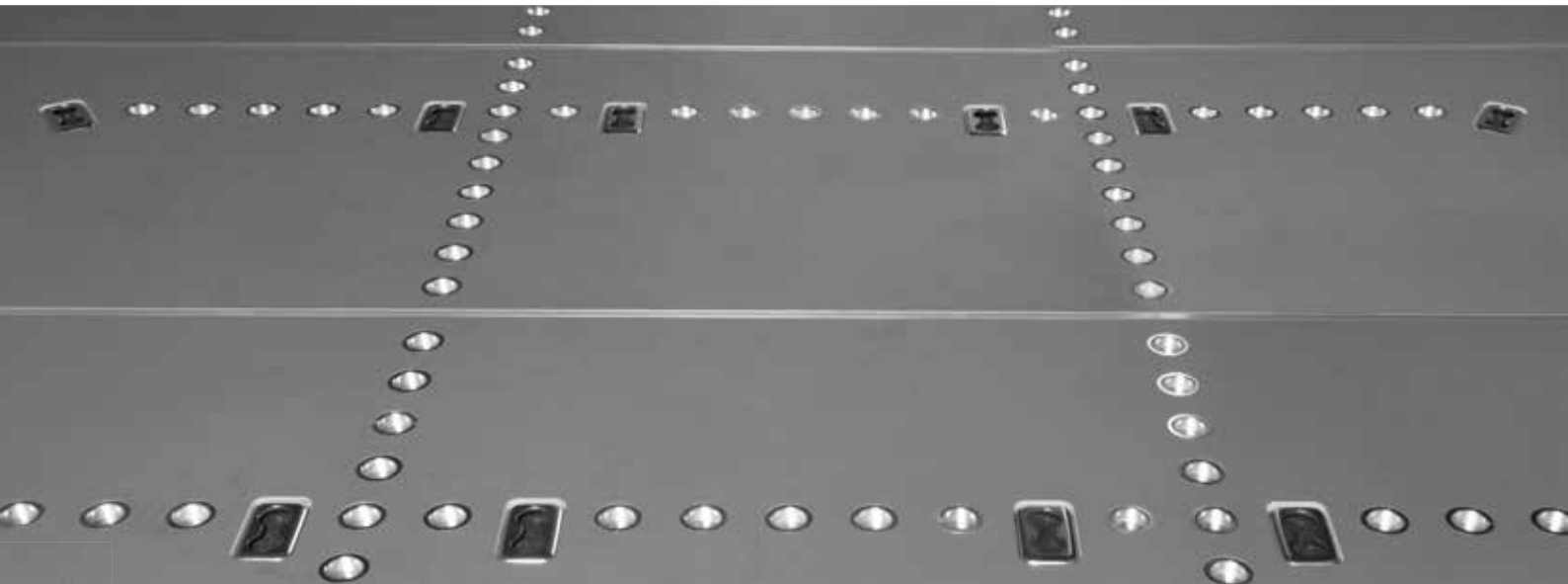

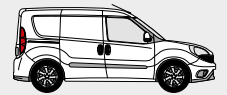

- Per veicolo con porta laterale destra e pareti lamierate.
- Pour véhicule avec porte latérale droite et parois en tôle.

Modello - Modèle L1 ^A	Modello - Modèle L1 ^B	Modello - Modèle L2 ^A	Modello - Modèle L2 ^B

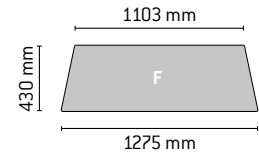

- Pannello retrocabina
- Panneau arrière cabine

- ^A Paratia in lamiera - Panneau de séparation tôlé
^B Paratia in rete con cancelletto - Panneau de séparation grillagé avec portillon

- Per veicolo con porta laterale destra e pareti lamierate.
- Pour véhicule avec porte latérale droite et parois en tôle.

Modello - Modèle L1 ^A	Modello - Modèle L1 ^B	Modello - Modèle L2 ^A	Modello - Modèle L2 ^B



- Per ogni pianale, ogni fila di fissaggi è composta da 4/6 punti di ancoraggio "Airline".
- Sur chaque plancher, chaque rangée d'arrimages se compose de 4/6 points d'ancrage "Airline".

- ^A Paratia in lamiera - Panneau de séparation tôlé
^B Paratia in rete con cancelletto - Panneau de séparation grillagé avec portillon

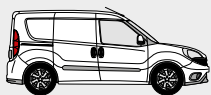

**Il fissaggio del carico
è di serie**

La fixation du
chargement de série



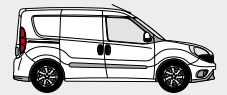

La soluzione d'**allestimento per furgoni SAFETY** di Store Van nasce per soddisfare i requisiti delle nuove disposizioni sulla sicurezza del carico. Nei moduli vengono integrati elementi strutturali che permettono l'utilizzo di sistemi di trattenuta "Airline", quali cinghie, reti e pali telescopici. Questo nuovo livello di **allestimento per veicoli commerciali** facilita l'ancoraggio di oggetti medio piccoli anche in presenza di pianali per furgoni privi di sistemi di ancoraggio, garantendo così la sicurezza del carico. Gli elementi di ancoraggio "Airline" del livello SAFETY aumentano la stabilità del modulo senza maggiorarne il peso in quanto integrati nella struttura stessa dell'allestimento.

La solution d'**aménagement pour fourgons SAFETY** de Store Van a été conçue pour répondre aux exigences des nouvelles dispositions en matière de sécurité du chargement. Dans les modules, les éléments structurels intégrés permettent d'utiliser des systèmes de maintien « Airline », tels que des sangles, des filets et des barres télescopiques. Ce nouveau niveau d'**aménagement pour véhicules utilitaires** facilite l'arrimage d'objets moyens et petits, même en cas de planails pour fourgons sans systèmes d'arrimage, ce qui garantit la sécurité du chargement. Les éléments d'arrimage « Airline » du niveau SAFETY améliorent la stabilité du module sans augmenter son poids car ils sont intégrés dans la structure même de l'aménagement.



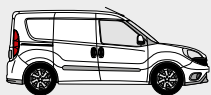

L1 H1

FIAT DOBLÒ
FURGONE LAMIERATO - FOURGON TÔLÉ

SAFETY

ESEMPI DI ALLESTIMENTO - EXEMPLES D'AMÉNAGEMENTS

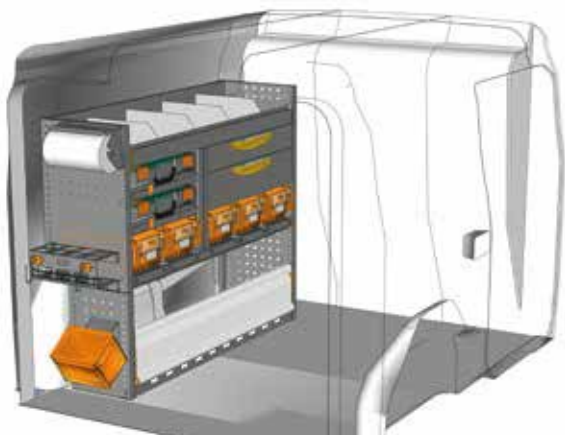

ESEMPIO - EXEMPLE

DO 1210 01*

L=1225 P=365 H=1000 mm

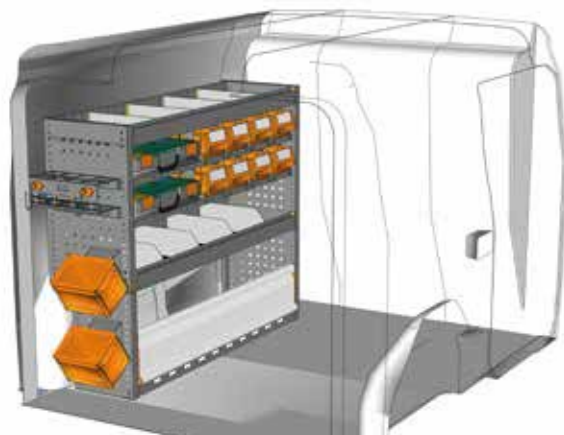
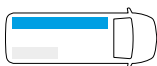

ESEMPIO - EXEMPLE

DO 1210 02*

L=1225 P=365 H=1000 mm

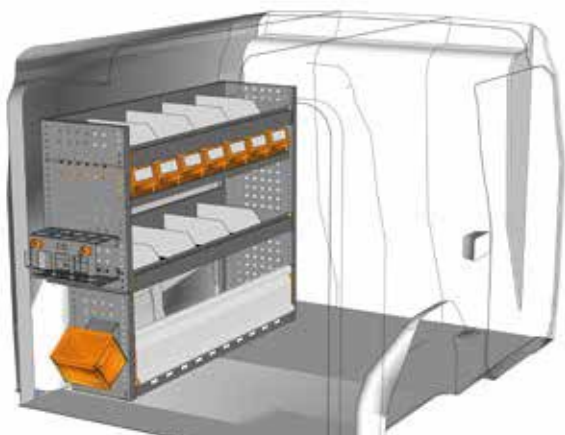
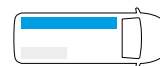

ESEMPIO - EXEMPLE

DO 1210 03*

L=1225 P=365 H=1000 mm

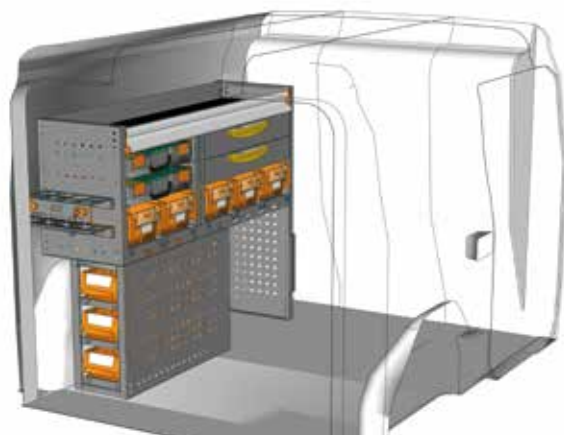
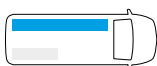

ESEMPIO - EXEMPLE

DO 1210 05*

L=1225 P=365 H=1000 mm

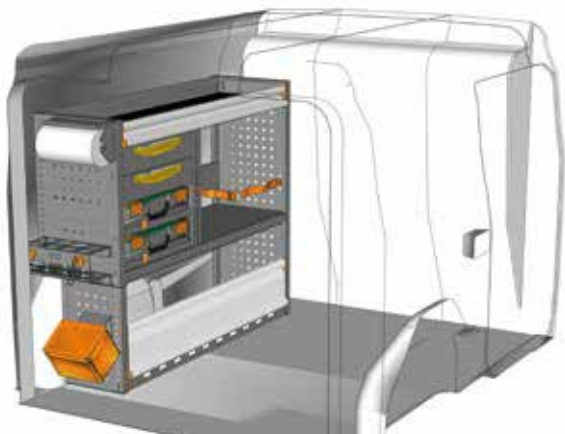
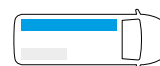

ESEMPIO - EXEMPLE

DO 1210 07*

L=1225 P=365 H=1000 mm

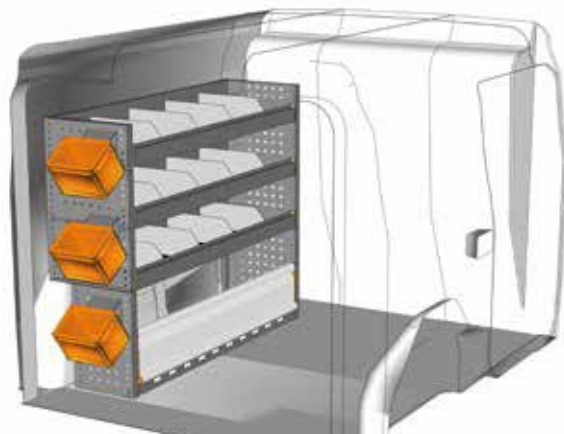
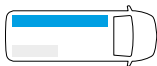

ESEMPIO - EXEMPLE

DO 1210 09*

L=1225 P=365 H=1000 mm

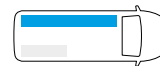

* Kit fissaggio incluso - Jeu de fixation inclus



ESEMPI DI ALLESTIMENTO - EXEMPLES D'AMÉNAGEMENTS

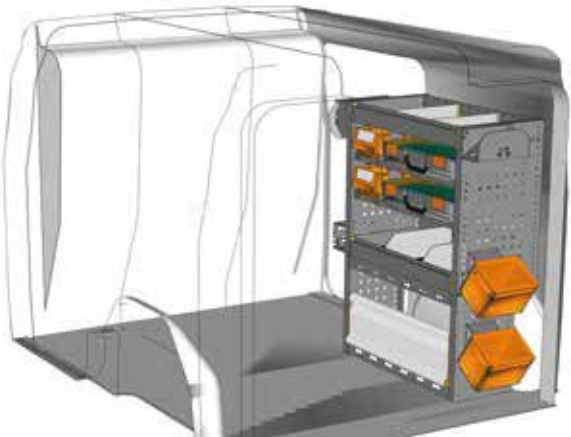

ESEMPIO - EXEMPLE

DO 0710 01*

L=717 P=365 H=1000 mm

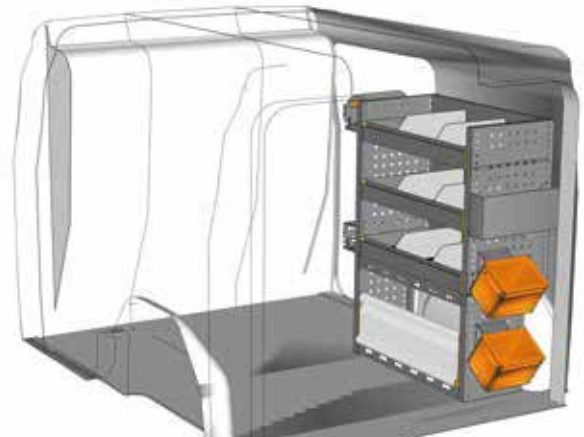
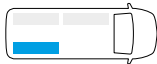

ESEMPIO - EXEMPLE

DO 0710 02*

L=717 P=365 H=1000 mm

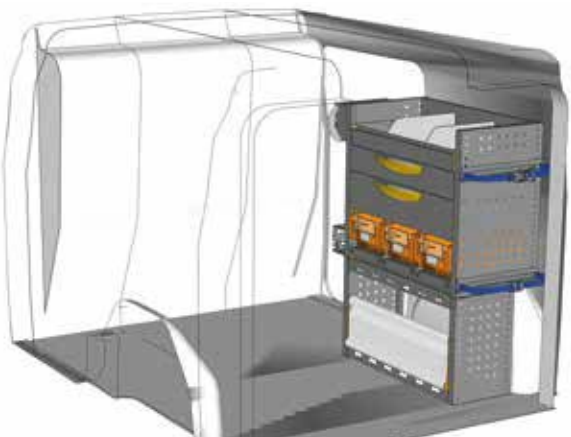
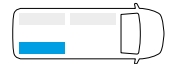

ESEMPIO - EXEMPLE

DO 0710 03*

L=717 P=365 H=1000 mm

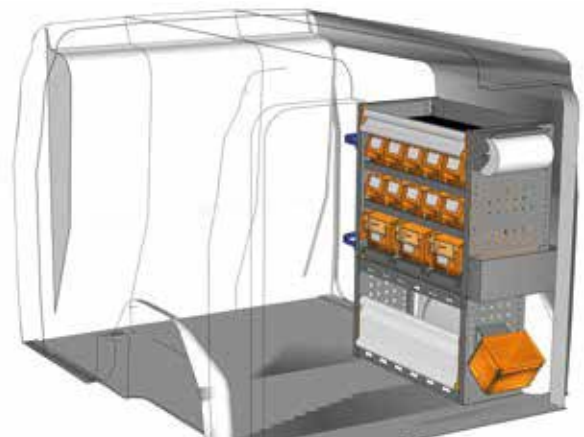
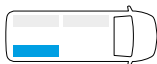

ESEMPIO - EXEMPLE

DO 0710 05*

L=717 P=365 H=1000 mm

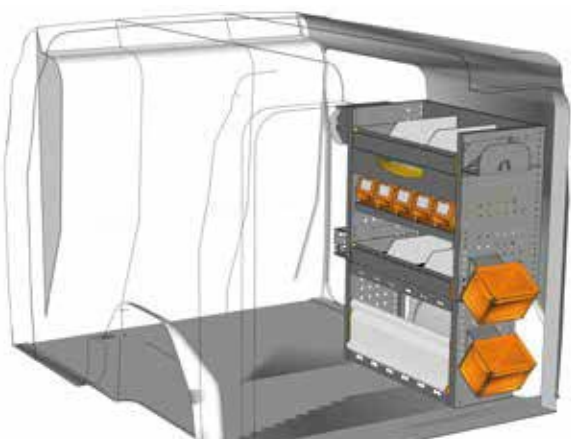
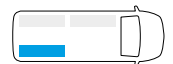

ESEMPIO - EXEMPLE

DO 0710 06*

L=717 P=365 H=1000 mm

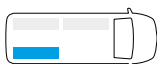

Non hai trovato il tuo allestimento?

Affidati ai nostri professionisti

Guarda il retro di questo catalogo e
contatta il punto Store Van piu vicino
oppure visita il nostro sito.

**Vous n'avez pas trouvé votre
équipement ? Confiez-vous
à nos professionnels**

Voir au dos de ce catalogue
et contactez le point StoreVan
le plus proche ou visitez notre site web.



* Kit fissaggio incluso - Jeu de fixation inclus

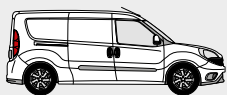

L2 H1

FIAT DOBLÒ
FURGONE LAMIERATO - FOURGON TÔLÉ

SAFETY

ESEMPI DI ALLESTIMENTO - EXEMPLES D'AMÉNAGEMENTS

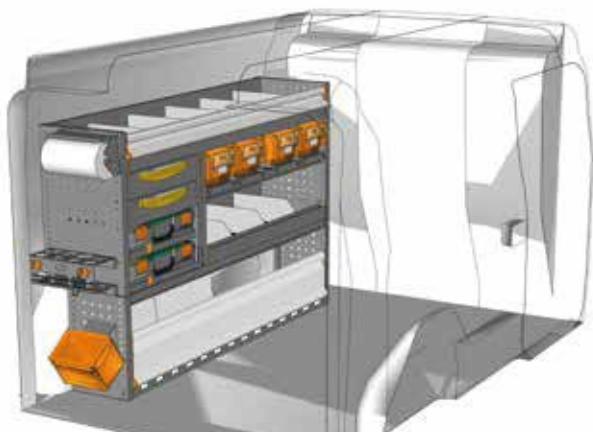

ESEMPIO - EXEMPLE

DO 1510 01*

L=1524 P=365 H=1000 mm

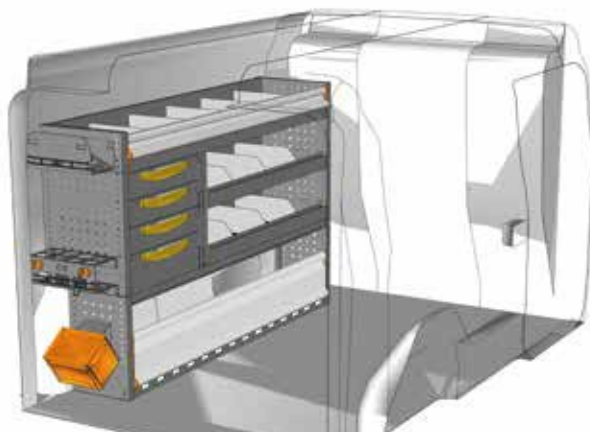
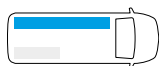

ESEMPIO - EXEMPLE

DO 1510 03*

L=1524 P=365 H=1000 mm

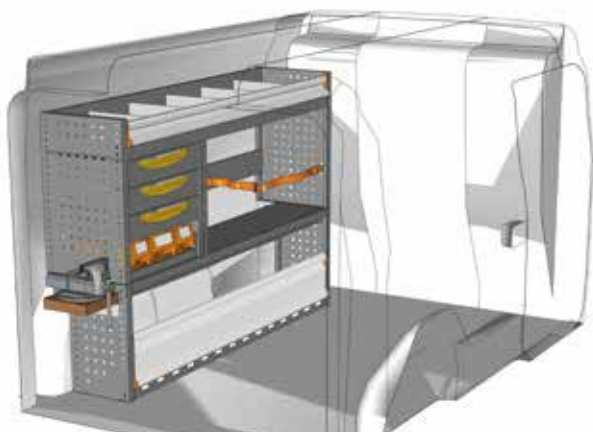
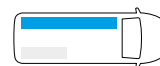

ESEMPIO - EXEMPLE

DO 1510 04*

L=1524 P=365 H=1050 mm

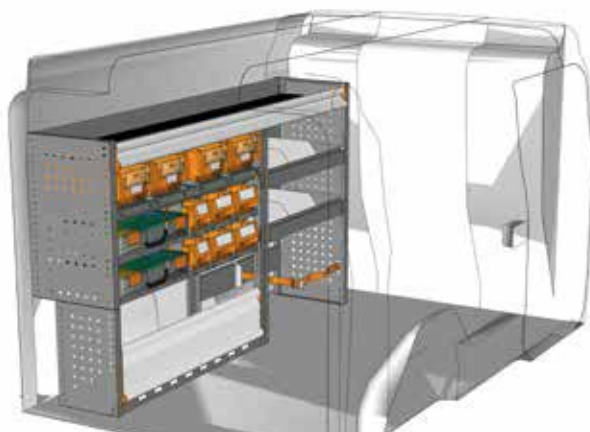
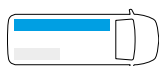

ESEMPIO - EXEMPLE

DO 1710 01*

L=1733 P=365 H=1000 mm

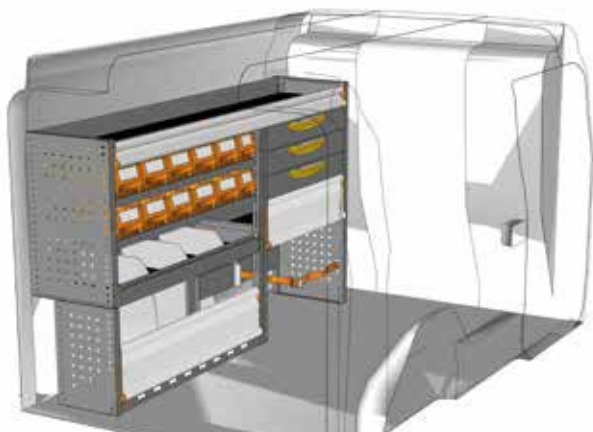
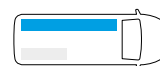

ESEMPIO - EXEMPLE

DO 1710 02*

L=1733 P=365 H=1000 mm

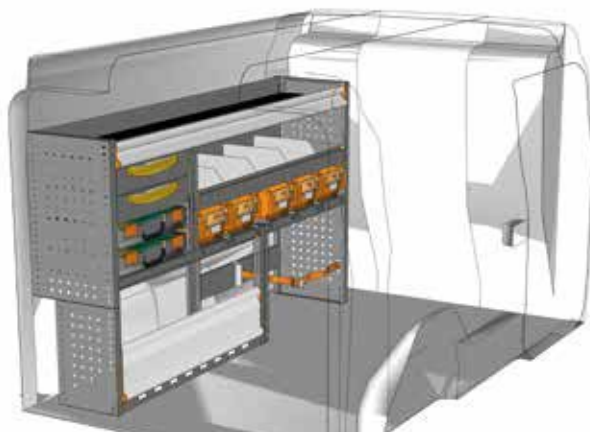
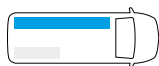

ESEMPIO - EXEMPLE

DO 1710 03*

L=1733 P=365 H=1000 mm



* Kit fissaggio incluso - Jeu de fixation inclus

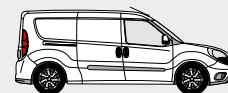

ESEMPI DI ALLESTIMENTO - EXEMPLES D'AMÉNAGEMENTS

FURGONE LAMIERATO - FOURGON TÔLE
FIAT DOBLÒ

SAFETY

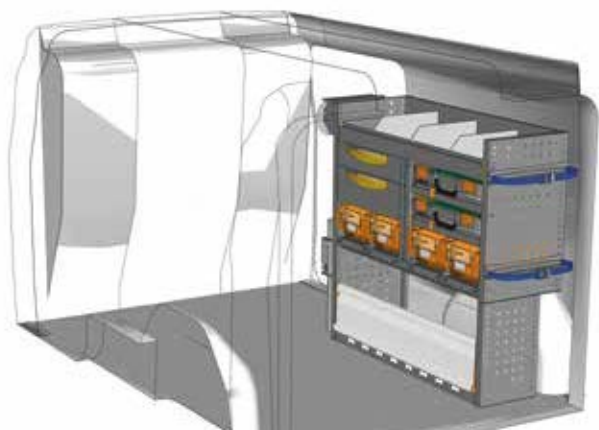

ESEMPIO - EXEMPLE

DO 1010 01*

L=1016 P=365 H=1000 mm

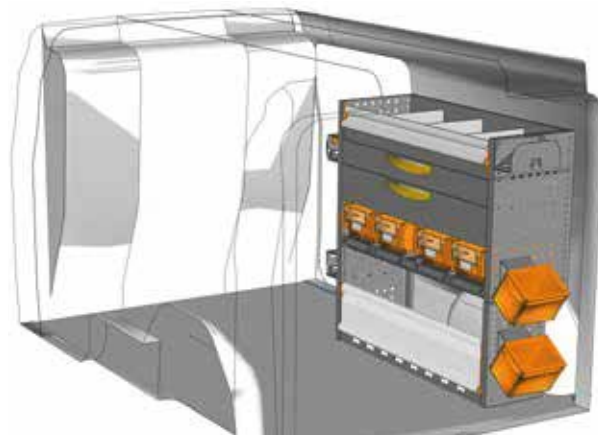
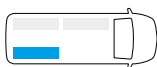

ESEMPIO - EXEMPLE

DO 1010 02*

L=1016 P=365 H=1000 mm

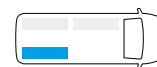

Vista da porta laterale
Vue de porte latérale

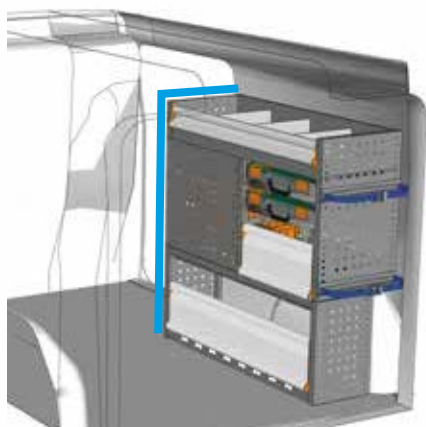
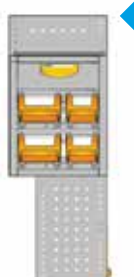

ESEMPIO - EXEMPLE

DO 1010 03*

L=1016 P=365 H=1000 mm

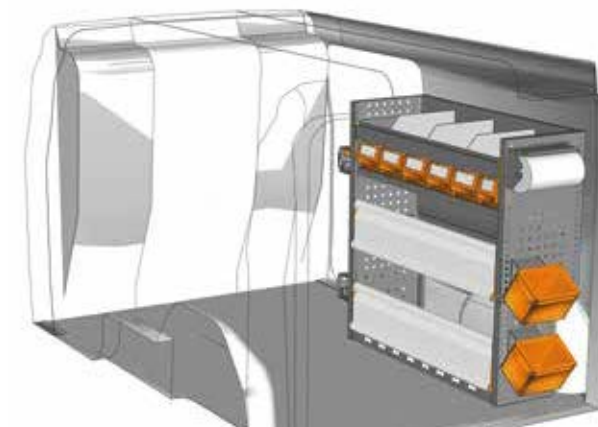
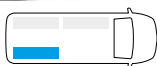

ESEMPIO - EXEMPLE

DO 1010 04*

L=1016 P=365 H=1000 mm

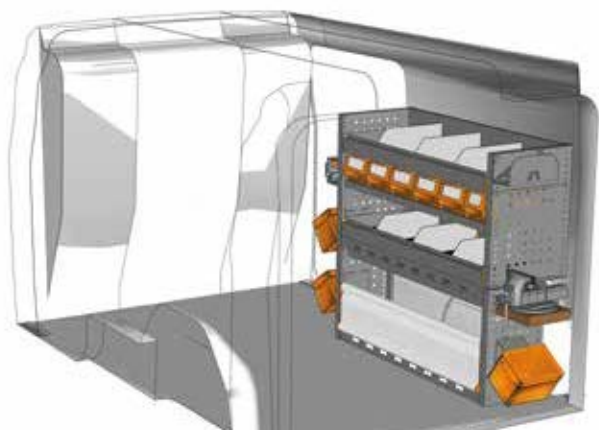
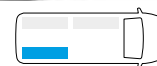

ESEMPIO - EXEMPLE

DO 1010 07*

L=1016 P=365 H=1000 mm

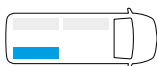

Non hai trovato il tuo allestimento?

Affidati ai nostri professionisti

Guarda il retro di questo catalogo e
contatta il punto Store Van piu vicino
oppure visita il nostro sito.

**Vous n'avez pas trouvé votre
équipement ? Confiez-vous
à nos professionnels**

Voir au dos de ce catalogue
et contactez le point StoreVan
le plus proche ou visitez notre site web.



* Kit fissaggio incluso - Jeu de fixation inclus

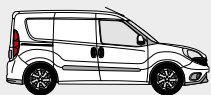

**L'integrazione perfetta
tra veicolo e allestimento
officina mobile**

**L'intégration parfaite
entre le véhicule et
l'aménagement de l'atelier
mobile**



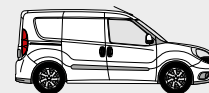

L'allestimento per furgoni PROFESSIONAL progettato da Store Van è integrato perfettamente nel veicolo ed è studiato appositamente per esaltarne le caratteristiche strutturali e dinamiche. I moduli di questo nuovo livello di **allestimento per veicolo commerciale**, come le scaffalature per furgoni, integrano, di serie, elementi per un perfetto fissaggio del carico al telaio del veicolo mediante l'utilizzo dei sistemi di trattenuta "Airline". Sono disponibili sistemi di trattenuta del carico verticali e orizzontali grazie al nuovo pianale SAFETY FLOOR.

L'aménagement pour fourgons PROFESSIONAL conçu par Store Van est parfaitement intégré au véhicule et a été spécialement étudié pour en optimiser les caractéristiques structurales et dynamiques. Les modules de ce nouveau niveau d'**aménagement pour véhicule utilitaire**, comme les rayonnages pour fourgons, comprennent, de série, des éléments conçus pour une fixation parfaite du chargement au châssis du véhicule grâce à l'utilisation des systèmes de maintien « Airline ». Des systèmes de maintien du chargement verticaux et horizontaux sont disponibles grâce au nouveau plancher SAFETY FLOOR.



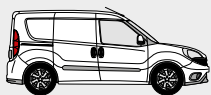

L1 H1

FIAT DOBLÒ
FURGONE LAMIERATO - FOURGON TÔLÉ

PROFESSIONAL

ESEMPI DI ALLESTIMENTO - EXEMPLES D'AMÉNAGEMENTS

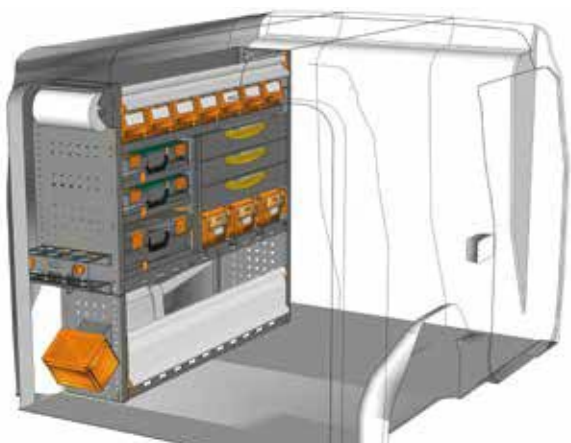

ESEMPIO - EXEMPLE

DO 1211 P1*

L=1225 P=365 H=1150 mm

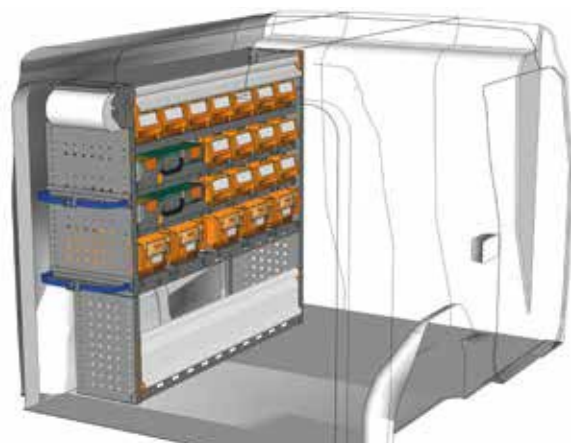
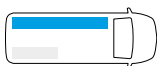

ESEMPIO - EXEMPLE

DO 1211 P2*

L=1225 P=365 H=1150 mm

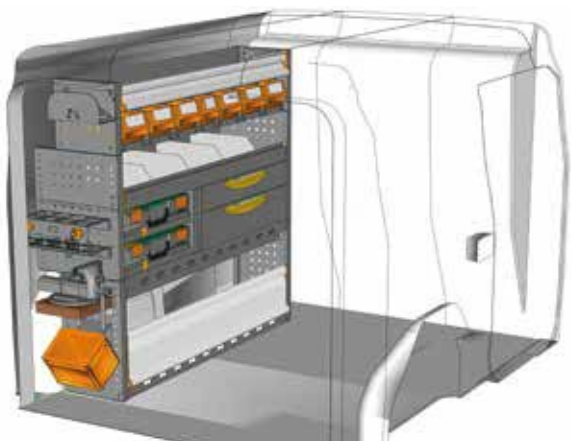
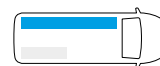

ESEMPIO - EXEMPLE

DO 1211 P3*

L=1225 P=365 H=1150 mm

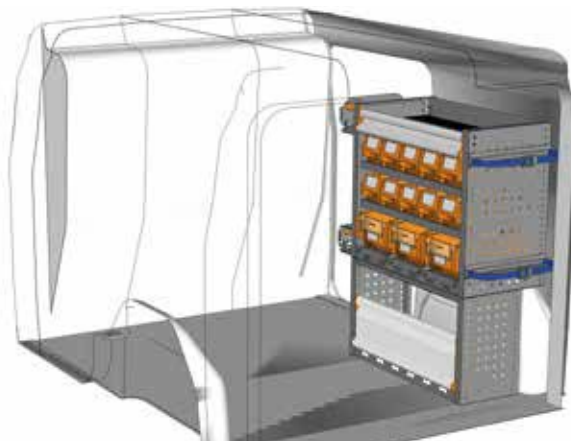
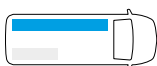

ESEMPIO - EXEMPLE

DO 0710 P1*

L=717 P=365 H=1000 mm

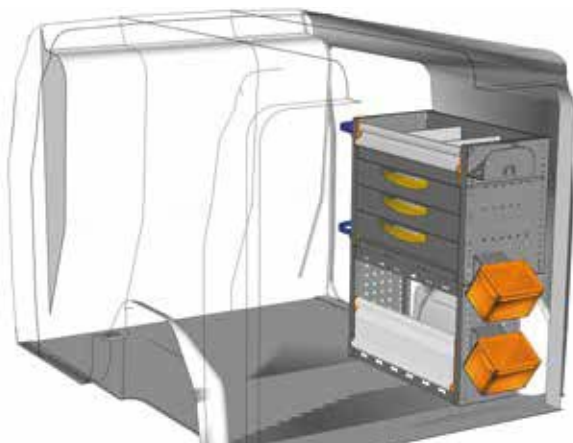
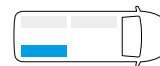

ESEMPIO - EXEMPLE

DO 0710 P2*

L=717 P=365 H=950 mm

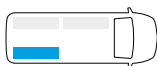

ESEMPIO - EXEMPLE

DO 0710 P3*

L=717 P=365 H=950 mm

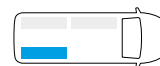

* Kit fissaggio incluso - Jeu de fixation inclus

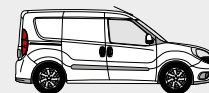

ESEMPI DI ALLESTIMENTO - EXEMPLES D'AMÉNAGEMENTS

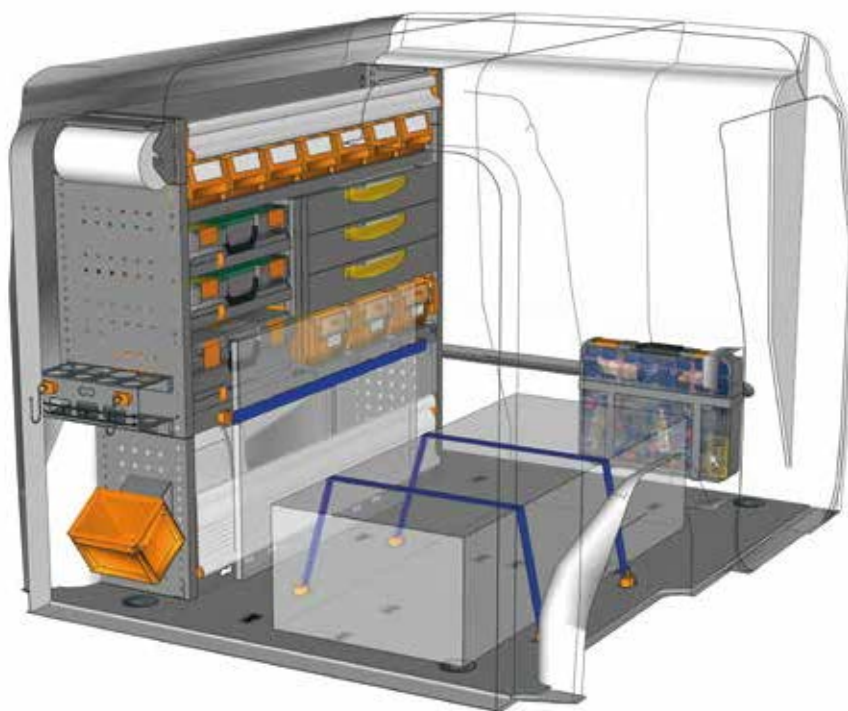

ESEMPIO - EXEMPLE

EXAMPLE DO L1H1 P1*



- | | |
|----------------|-------------|
| 1 x DO 1211 P1 | 2 x V22124 |
| 1 x DO 10K1 B0 | 2 x V22148 |
| 1 x V22585 | 1 x YELLOW |
| 1 x V18029 10 | 4 x V225820 |
| 2 x V22106 | |
| 1 x BOX080 | |
| 1 x CPV080 | |
| 2 x V22136 | |

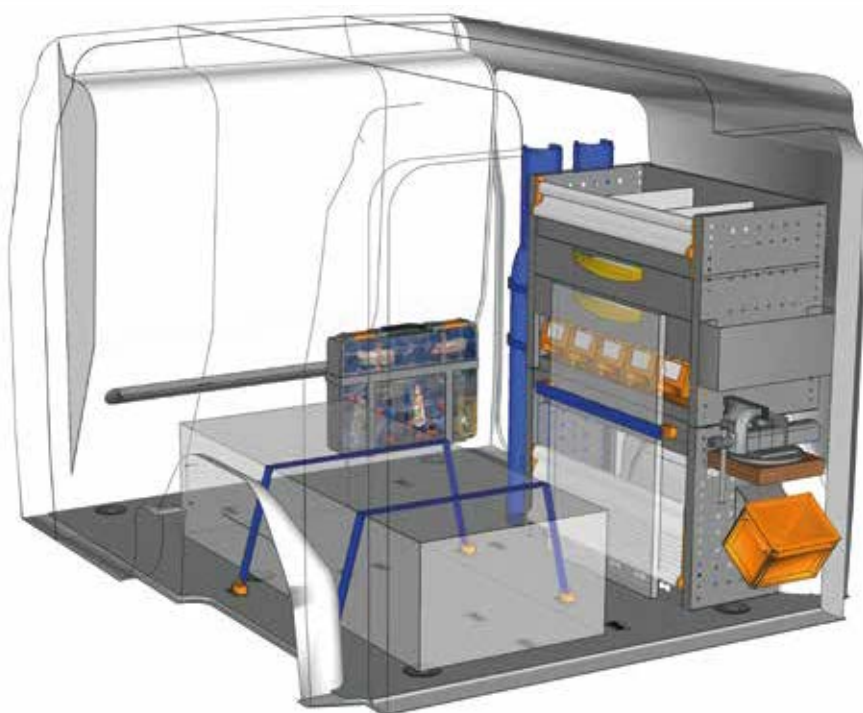

ESEMPIO - EXEMPLE

EXAMPLE DO L1H1 P2*



- | | |
|----------------|-------------|
| 1 x DO 0710 P3 | 2 x V22124 |
| 1 x DO 10K1 B0 | 2 x V22148 |
| 1 x V22585 | 1 x YELLOW |
| 1 x V18029 10 | 4 x V225820 |
| 2 x V22106 | |
| 1 x BOX080 | |
| 1 x CPV080 | |
| 2 x V22136 | |

FURGONE LAMIERATO - FOURGON TÔLE
FIAT DOBLÒ
PROFESSIONAL

Non hai trovato il tuo allestimento?

Affidati ai nostri professionisti

Guarda il retro di questo catalogo e
contatta il punto Store Van piu vicino
oppure visita il nostro sito.

**Vous n'avez pas trouvé votre
équipement ? Confiez-vous
à nos professionnels**

Voir au dos de ce catalogue
et contactez le point StoreVan
le plus proche ou visitez notre site web.

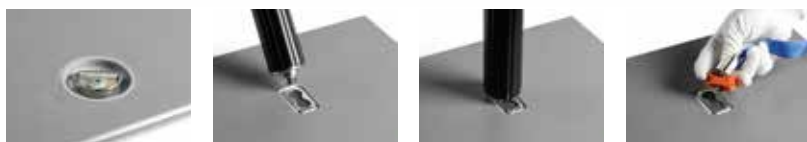

vedi pag. 10/11
voir page 10/11

* Kit fissaggio incluso - Jeu de fixation inclus

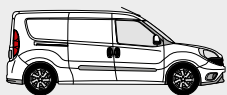

L2 H1

FIAT DOBLÒ
FURGONE LAMIERATO - FOURGON TÔLÉ

PROFESSIONAL

ESEMPI DI ALLESTIMENTO - EXEMPLES D'AMÉNAGEMENTS

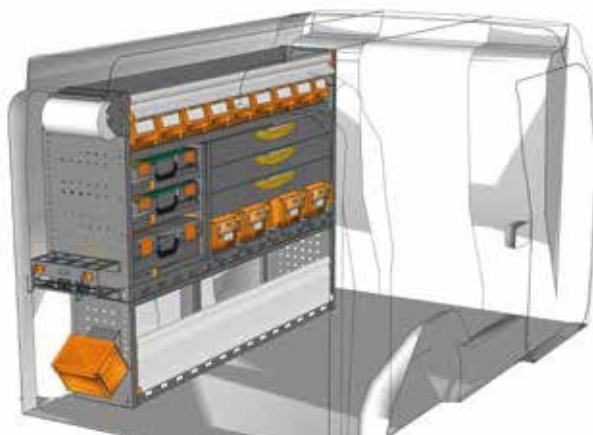

ESEMPIO - EXEMPLE

DO 1511 P1*

L=1524 P=365 H=1150 mm

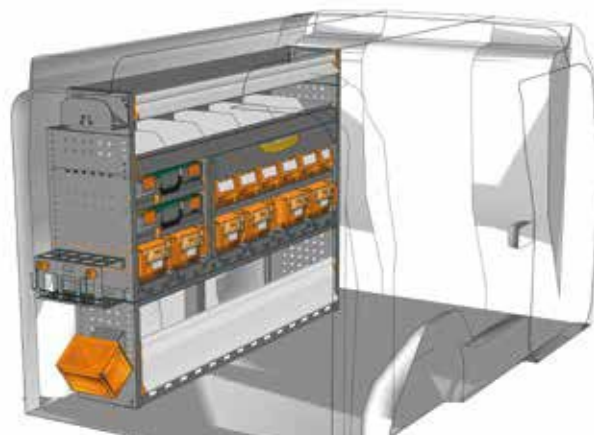
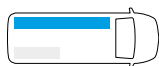

ESEMPIO - EXEMPLE

DO 1511 P2*

L=1524 P=365 H=1150 mm

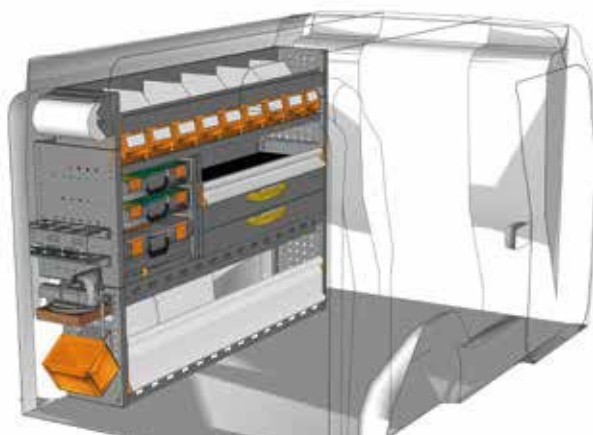
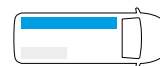

ESEMPIO - EXEMPLE

DO 1511 P3*

L=1524 P=365 H=1150 mm

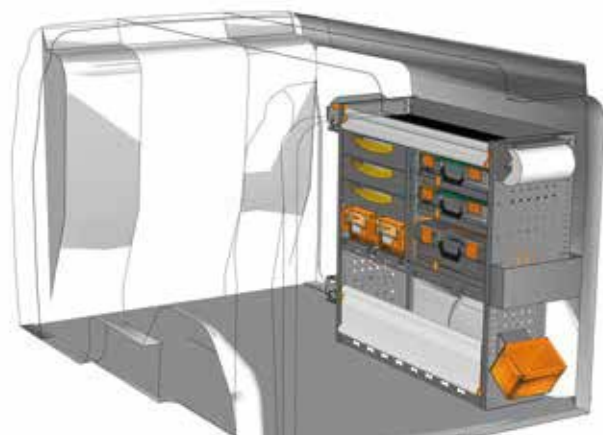
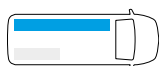

ESEMPIO - EXEMPLE

DO 1010 P1*

L=1016 P=365 H=1000 mm

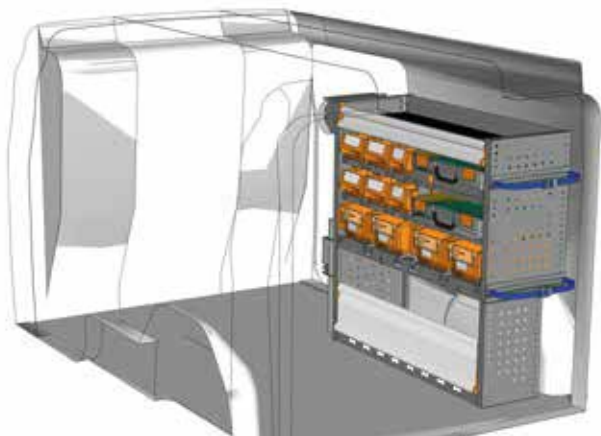
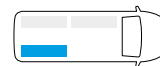

ESEMPIO - EXEMPLE

DO 1010 P2*

L=1016 P=365 H=1000 mm

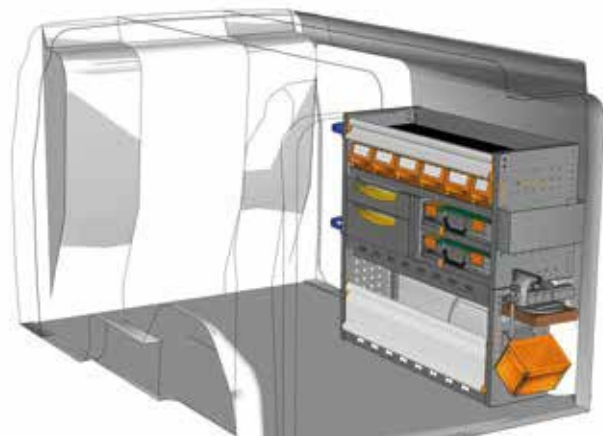

ESEMPIO - EXEMPLE

DO 1010 P3*

L=1016 P=365 H=1000 mm

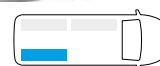

* Kit fissaggio incluso - Jeu de fixation inclus

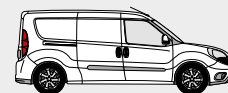

ESEMPI DI ALLESTIMENTO - EXEMPLES D'AMÉNAGEMENTS

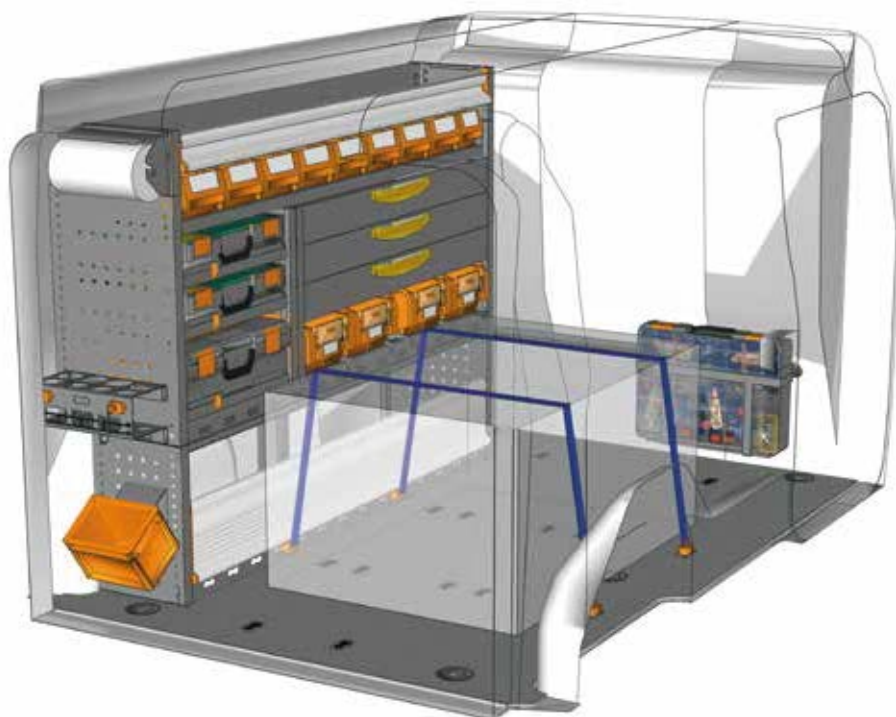

ESEMPIO - EXEMPLE

EXAMPLE DO L2H1 P1*



- | | |
|----------------|-------------|
| 1 x DO 1511 P1 | 2 x V22124 |
| 1 x DO 20K1 B0 | 2 x V22148 |
| 1 x V22585 | 1 x YELLOW |
| 1 x V18029 10 | 4 x V225820 |
| 2 x V22106 | |
| 1 x BOX080 | |
| 1 x CPV080 | |
| 2 x V22136 | |

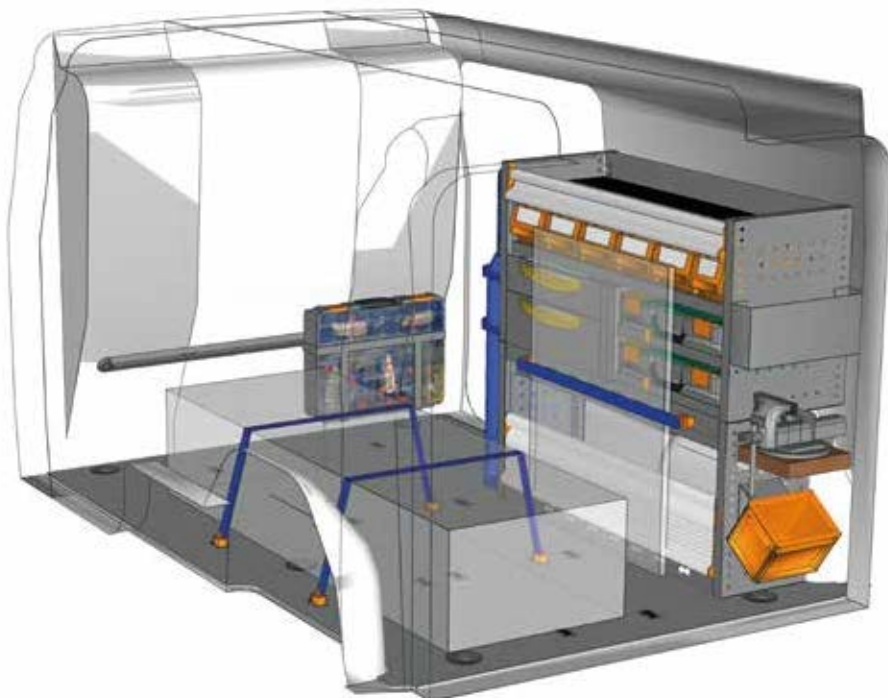

ESEMPIO - EXEMPLE

EXAMPLE DO L2H1 P2*



- | | |
|----------------|-------------|
| 1 x DO 1010 P3 | 2 x V22124 |
| 1 x DO 20K1 B0 | 2 x V22148 |
| 1 x V22585 | 1 x YELLOW |
| 1 x V18029 10 | 4 x V225820 |
| 2 x V22106 | |
| 1 x BOX080 | |
| 1 x CPV080 | |
| 2 x V22136 | |

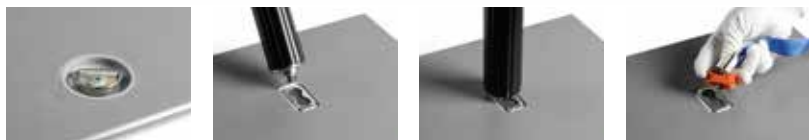

vedi pag. 10/11
voir page 10/11

* Kit fissaggio incluso - Jeu de fixation inclus

Non hai trovato il tuo allestimento?
Affidati ai nostri professionisti
Guarda il retro di questo catalogo e
contatta il punto Store Van piu vicino
oppure visita il nostro sito.

**Vous n'avez pas trouvé votre
équipement ? Confiez-vous
à nos professionnels**
Voir au dos de ce catalogue
et contactez le point StoreVan
le plus proche ou visitez notre site web.



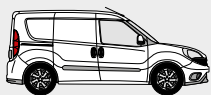

La mobilità oltre il veicolo

La mobilità au-delà du véhicule



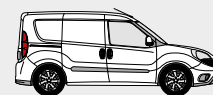

La soluzione MOBILE integra gli allestimenti per veicoli commerciali Store Van con le valigette portaminuterie serie STORE BOX 102 – 136 – 238 e il relativo carrellino per facilitare l'utilizzatore dell'**officina mobile** nel trasporto della merce e dell'attrezzatura dal veicolo al luogo di lavoro.

I nuovi elementi di ancoraggio "Airline" aumentano la stabilità del modulo senza influenzarne il peso. Anche in questo caso vengono integrati nella scaffalatura degli elementi che permettono l'uso dei sistemi di trattenuta "Airline". Possono essere scelti sistemi di fissaggio del carico sia verticali che orizzontali grazie anche all'introduzione del pianale SAFETY FLOOR.

La solution MOBILE comprend les aménagements pour véhicules utilitaires Store Van avec les malles pour les petits composants série STORE BOX 102 – 136 – 238 et le chariot pour aider l'utilisateur de l'**atelier mobile** dans les opérations de transport de la marchandise et de l'outillage entre le véhicule et le lieu d'intervention.

Les nouveaux éléments d'arrimage « Airline » améliorent la stabilité du module sans augmenter son poids. Dans ce cas également, des éléments intégrés dans le rayonnage permettent l'utilisation des systèmes de maintien « Airline ». Il est également possible de choisir des systèmes de fixation du chargement aussi bien verticaux qu'horizontaux grâce à l'adoption du plancher SAFETY FLOOR.



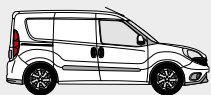

L1 H1

FIAT DOBLÒ
FURGONE LAMIERATO - FOURGON TÔLÉ

MOBILE

ESEMPI DI ALLESTIMENTO - EXEMPLES D'AMÉNAGEMENTS

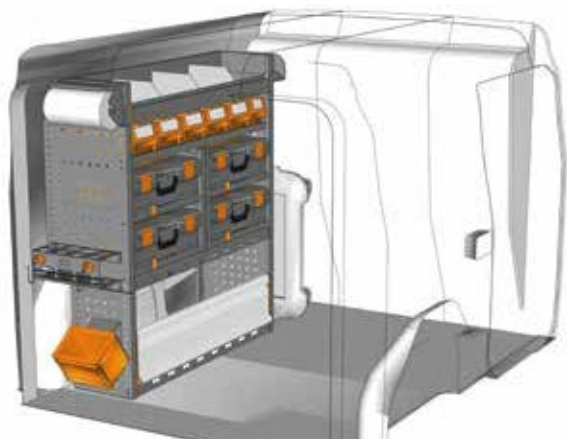

ESEMPIO - EXEMPLE

DO 1011 M1*

L=1016 P=365 H=1150 mm

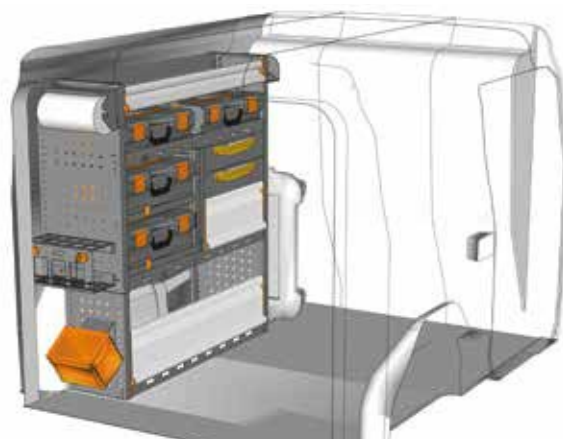
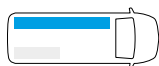

ESEMPIO - EXEMPLE

DO 1011 M2*

L=1016 P=365 H=1150 mm

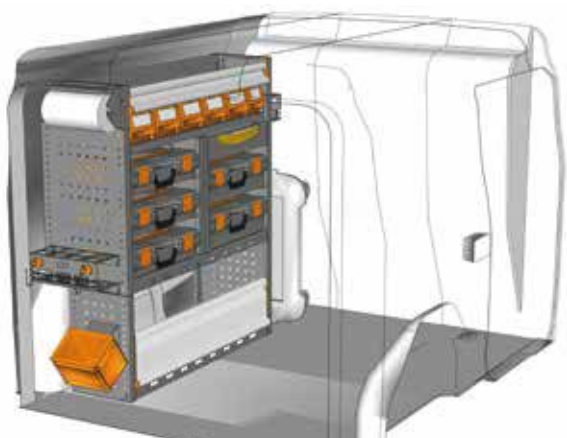
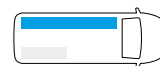

ESEMPIO - EXEMPLE

DO 1011 M3*

L=1016 P=365 H=1150 mm

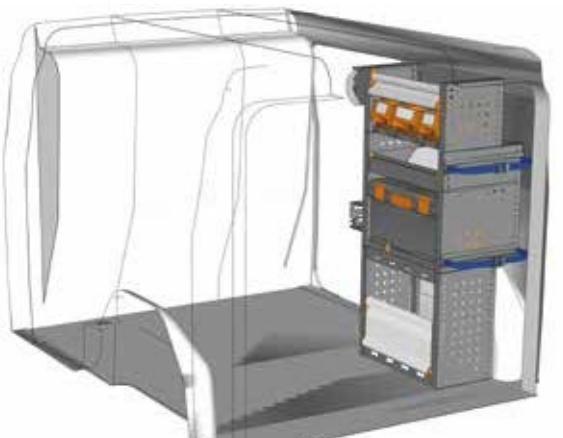
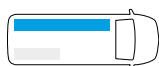

ESEMPIO - EXEMPLE

DO 0511 M1*

L=508 P=365 H=1150 mm

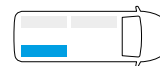

ESEMPIO - EXEMPLE

DO 0511 M2*

L=508 P=365 H=1150 mm

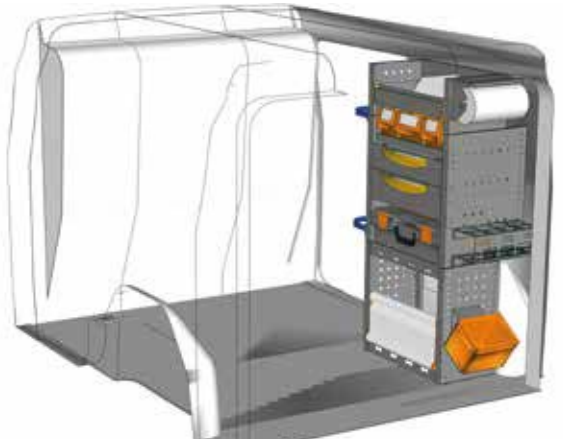
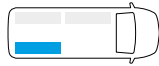

ESEMPIO - EXEMPLE

DO 0511 M3*

L=508 P=365 H=1150 mm

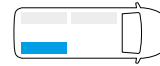

* Kit fissaggio incluso - Jeu de fixation inclus

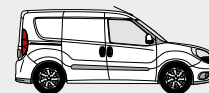

ESEMPIO DI ALLESTIMENTO - EXEMPLES D'AMÉNAGEMENTS

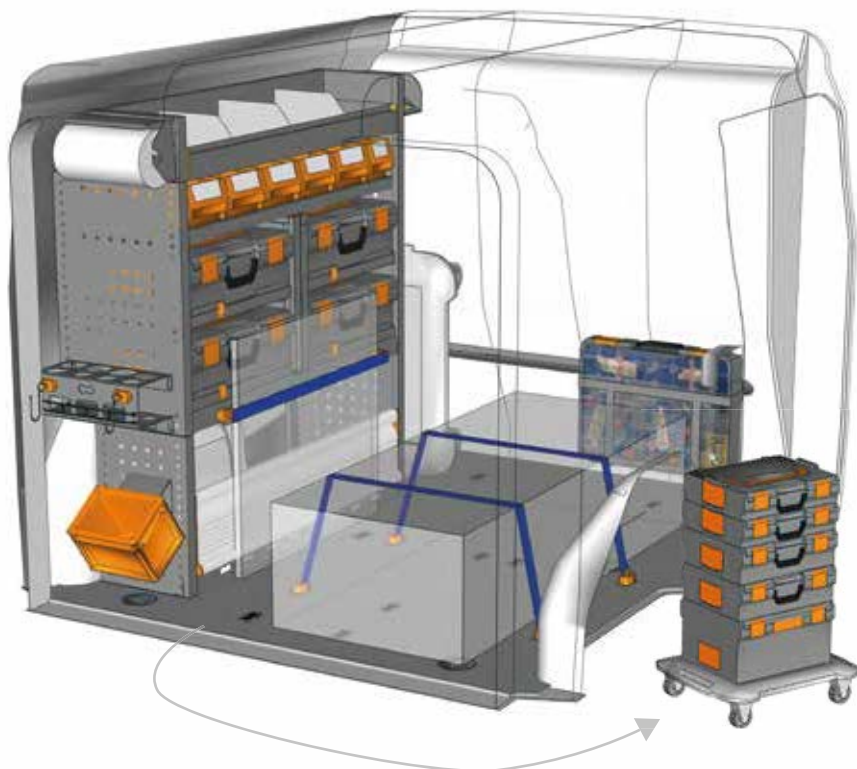

ESEMPIO - EXEMPLE

EXAMPLE DO L1H1 M1*



- | | |
|----------------|-------------|
| 1 x DO 1011 M1 | 2 x V22124 |
| 1 x DO 10K1 B0 | 2 x V22148 |
| 1 x V22585 | 1 x YELLOW |
| 1 x V18029 10 | 4 x V225820 |
| 2 x V22106 | |
| 1 x BOX080 | |
| 1 x CPV080 | |
| 2 x V22136 | |

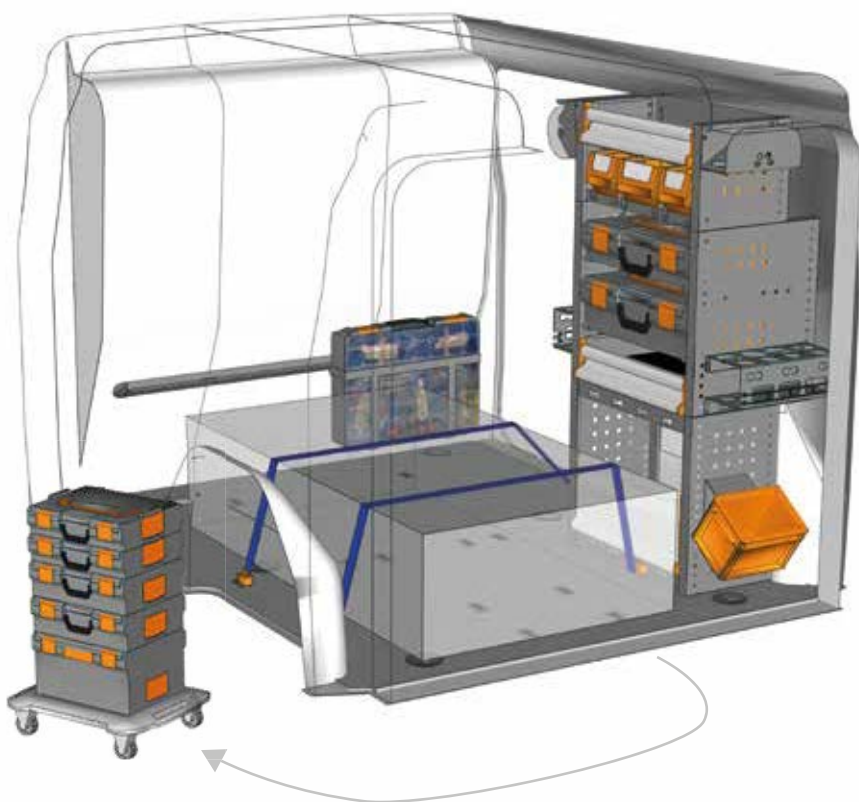

ESEMPIO - EXEMPLE

EXAMPLE DO L1H1 M2*



- | | |
|----------------|-------------|
| 1 x DO 0511 M2 | 2 x V22124 |
| 1 x DO 10K1 B0 | 2 x V22148 |
| 1 x V22585 | 1 x YELLOW |
| 1 x V18029 10 | 4 x V225820 |
| 2 x V22106 | |
| 1 x BOX080 | |
| 1 x CPV080 | |
| 2 x V22136 | |

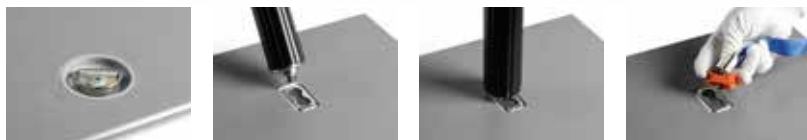

vedi pag. 10/11
voir page 10/11

* Kit fissaggio incluso - Jeu de fixation inclus

Non hai trovato il tuo allestimento?
Affidati ai nostri professionisti
Guarda il retro di questo catalogo e
contatta il punto Store Van piu vicino
oppure visita il nostro sito.

**Vous n'avez pas trouvé votre
équipement ? Confiez-vous
à nos professionnels**
Voir au dos de ce catalogue
et contactez le point StoreVan
le plus proche ou visitez notre site web.



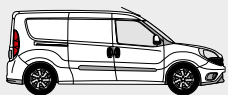

L2 H1

FIAT DOBLÒ
FURGONE LAMIERATO - FOURGON TÔLÉ

MOBILE

ESEMPI DI ALLESTIMENTO - EXEMPLES D'AMÉNAGEMENTS

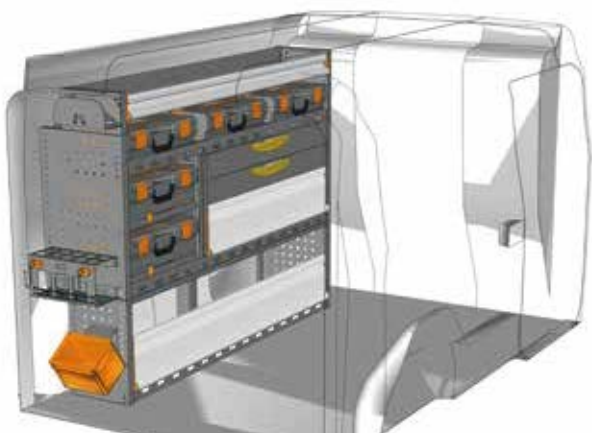

ESEMPIO - EXEMPLE

DO 1511 M1*

L=1524 P=365 H=1150 mm

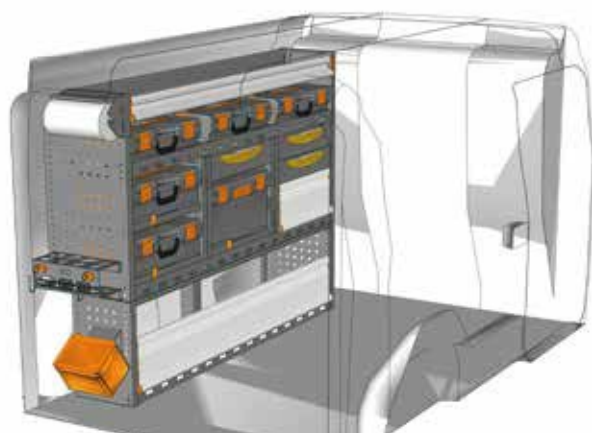
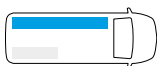

ESEMPIO - EXEMPLE

DO 1511 M2*

L=1524 P=365 H=1150 mm

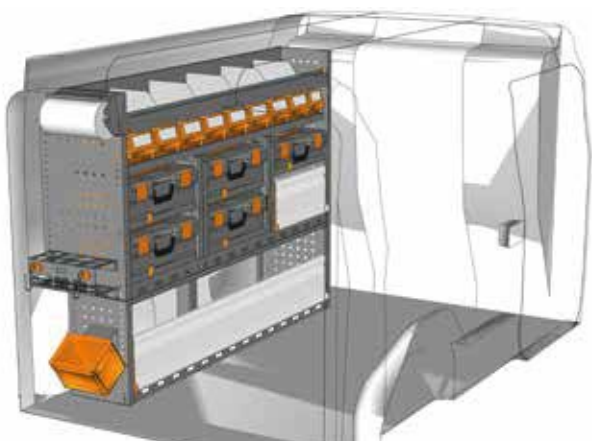
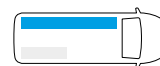

ESEMPIO - EXEMPLE

DO 1511 M3*

L=1524 P=365 H=1150 mm

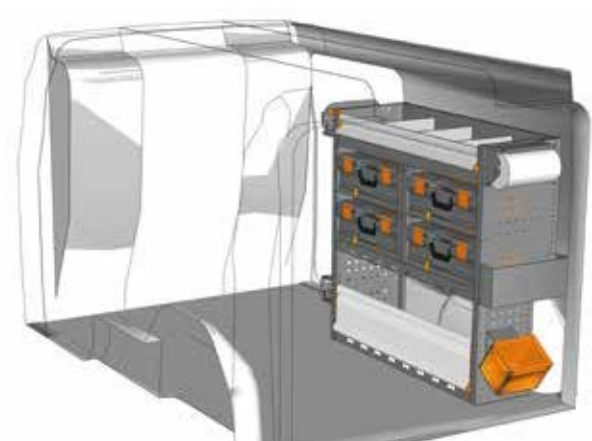
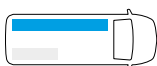

ESEMPIO - EXEMPLE

DO 1010 M1*

L=1016 P=365 H=1000 mm

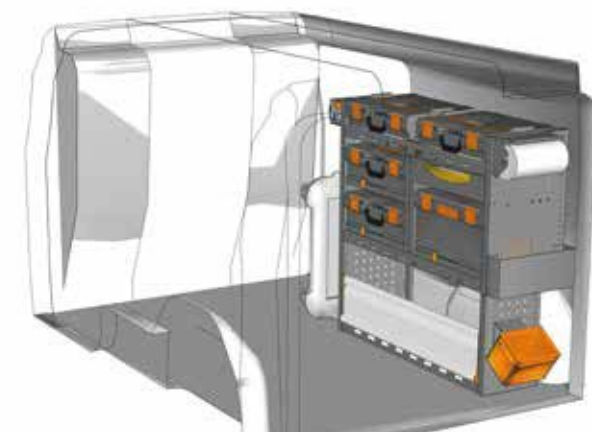
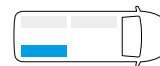

ESEMPIO - EXEMPLE

DO 1010 M2*

L=1016 P=365 H=1000 mm

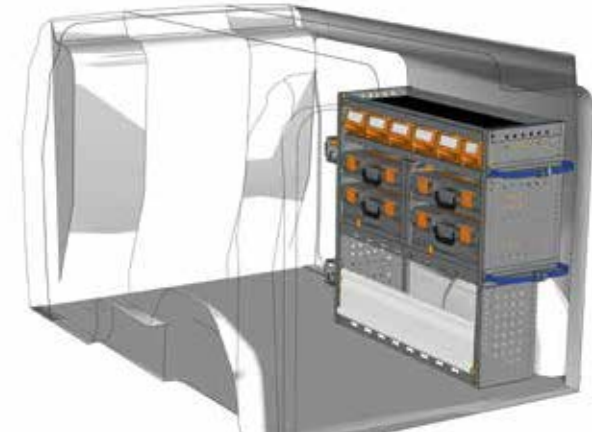
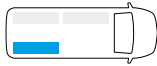

ESEMPIO - EXEMPLE

DO 1010 M3*

L=1016 P=365 H=1000 mm

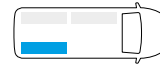

* Kit fissaggio incluso - Jeu de fixation inclus

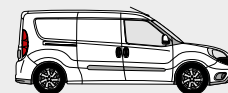

ESEMPIO DI ALLESTIMENTO - EXEMPLES D'AMÉNAGEMENTS

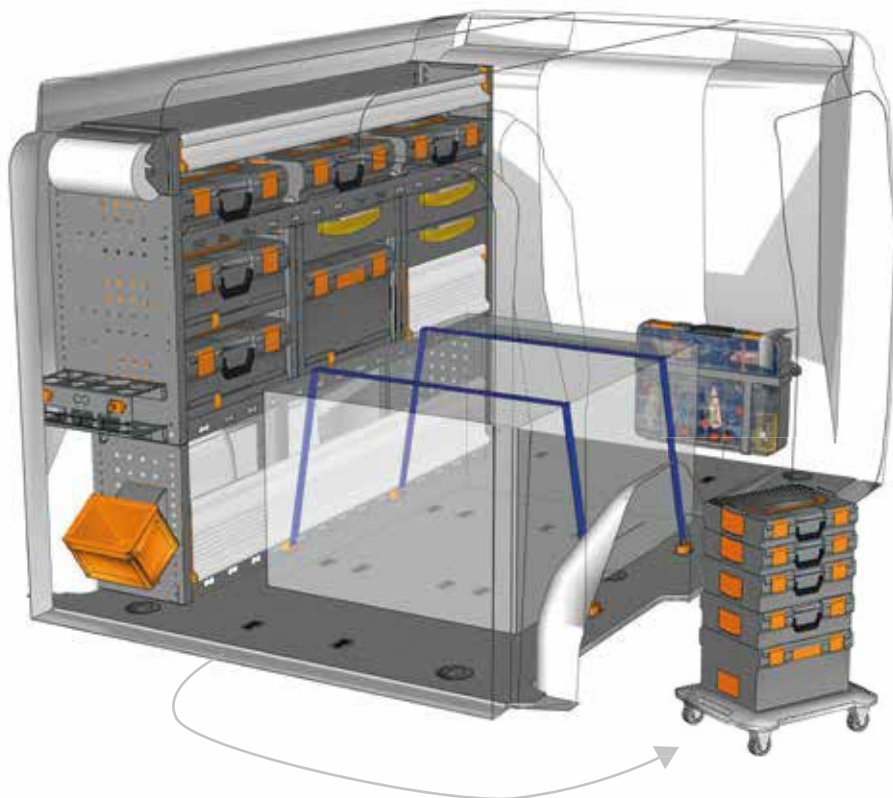

ESEMPIO - EXEMPLE

EXAMPLE DO L2H1 M1*



- | | |
|----------------|-------------|
| 1 x DO 1511 M1 | 2 x V22124 |
| 1 x DO 20K1 B0 | 2 x V22148 |
| 1 x V22585 | 1 x YELLOW |
| 1 x V18029 10 | 4 x V225820 |
| 2 x V22106 | |
| 1 x BOX080 | |
| 1 x CPV080 | |
| 2 x V22136 | |

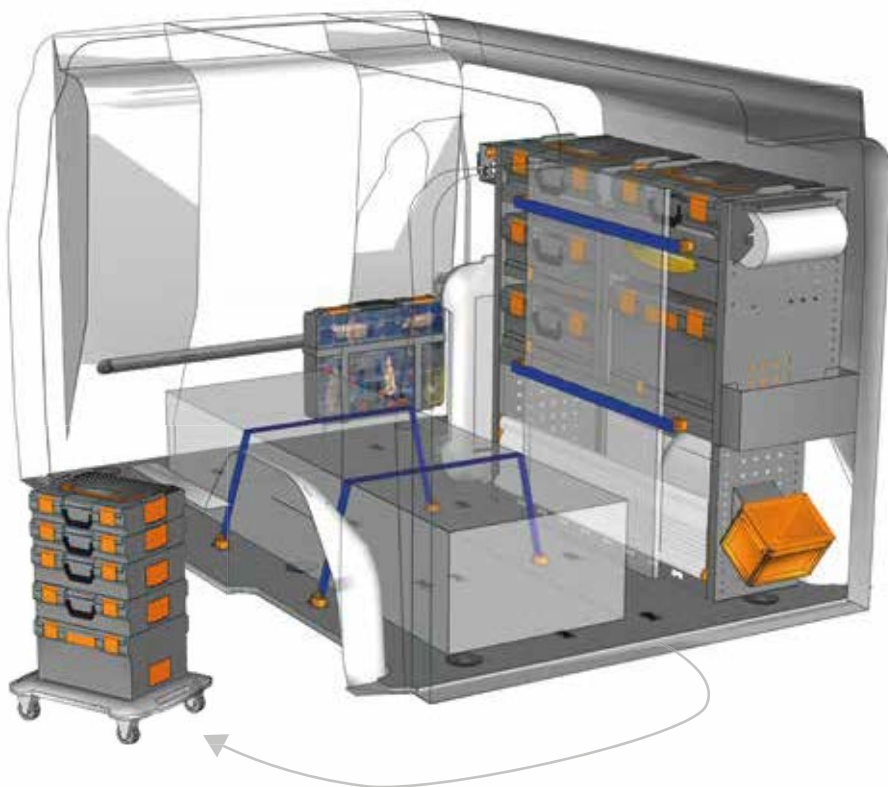

ESEMPIO - EXEMPLE

EXAMPLE DO L2H1 M2*



- | | |
|----------------|-------------|
| 1 x DO 1010 M2 | 2 x V22124 |
| 1 x DO 20K1 B0 | 2 x V22148 |
| 1 x V22585 | 1 x YELLOW |
| 1 x V18029 10 | 4 x V225820 |
| 2 x V22106 | |
| 1 x BOX080 | |
| 1 x CPV080 | |
| 2 x V22136 | |

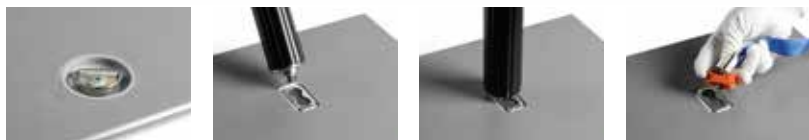

vedi pag. 10/11
voir page 10/11

* Kit fissaggio incluso - Jeu de fixation inclus

Non hai trovato il tuo allestimento?
Affidati ai nostri professionisti
Guarda il retro di questo catalogo e
contatta il punto Store Van piu vicino
oppure visita il nostro sito.

**Vous n'avez pas trouvé votre
équipement ? Confiez-vous
à nos professionnels**
Voir au dos de ce catalogue
et contactez le point StoreVan
le plus proche ou visitez notre site web.



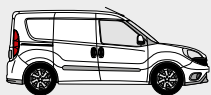

**L'allestimento ergonomico che semplifica
il lavoro in sicurezza**

**L'aménagement ergonomique qui simplifie
le travail en toute sécurité**

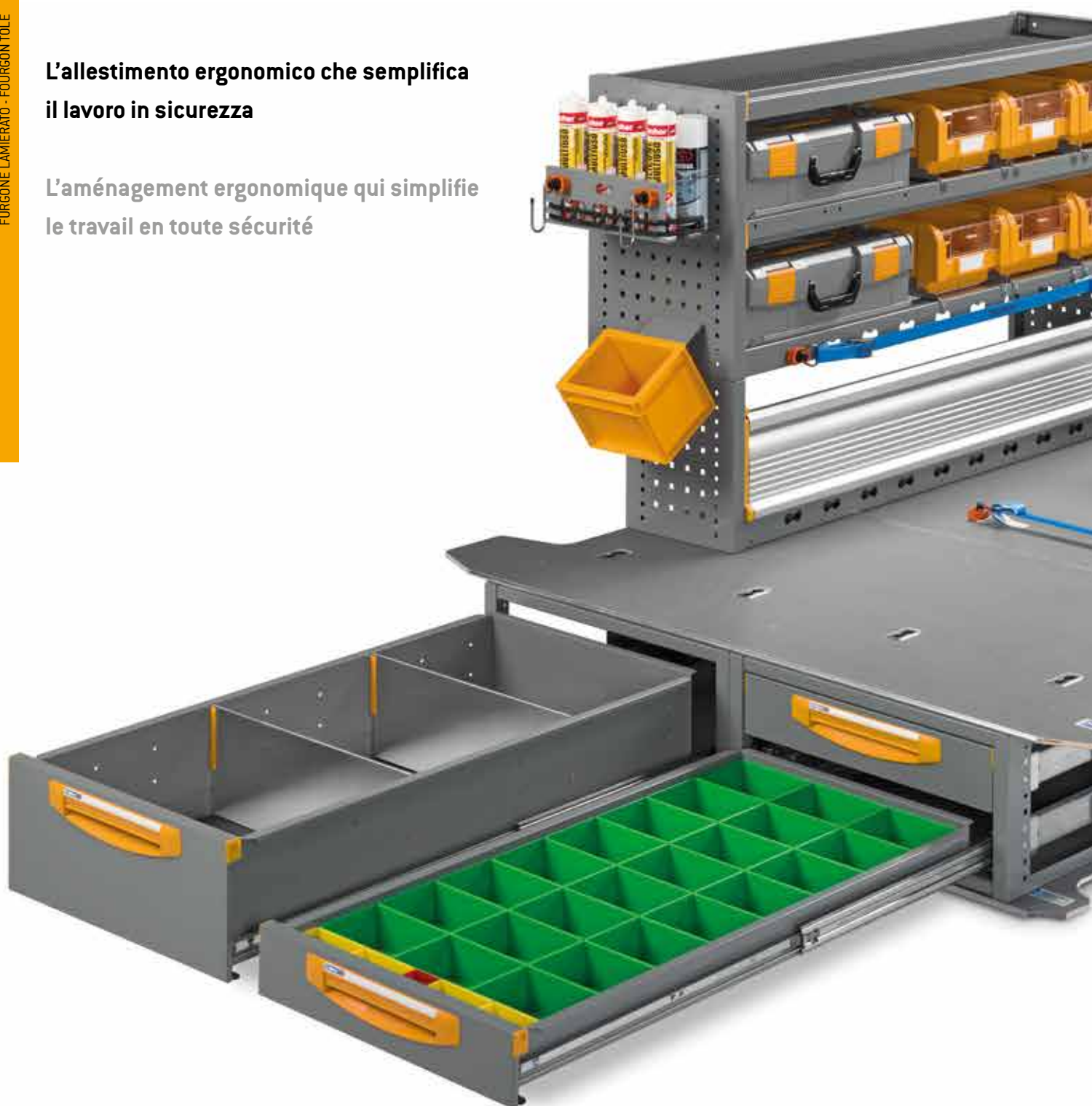

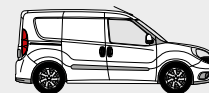

FLOOR UP è l'allestimento per furgoni a doppio livello con cassettiere sottopianale sviluppato da Store Van per **migliorare la capacità di carico dei veicoli commerciali con meno di 5 m³ di volume di carico**. Lo stoccaggio e la movimentazione merci sono stati studiati per migliorare l'ergonomia e rendere il trasporto semplice e veloce.

Particolare attenzione è stata dedicata all'utilizzo, e conseguente necessità di trasporto in sicurezza, di utensili, elettroutensili e attrezzature di vario genere.

Questo risultato è stato ottenuto grazie all'introduzione di cassette sotto pianale particolarmente lunghi e con un ampio volume interno, posti nella parte posteriore e laterale del veicolo in corrispondenza delle porte. Le pareti laterali a tutta altezza del cassetto evitano la fuoriuscita del materiale durante il trasporto.

I cassette sotto pianale coniugano una elevata portata, **80 kg per cassetto**, con una ampia gamma di materiale di separazione, quali divisori spostabili in alluminio e box in plastica di varie dimensioni per suddividere e bloccare il carico contenuto al loro interno.

Sulla parte superiore dell'allestimento è stato inserito un pianale marino in betulla a 9 strati con uno speciale rivestimento ad alta resistenza e con coefficiente di attrito certificato TUV. Vengono forniti di serie **12 punti di ancoraggio supplementari AIRLINE** con trazione pari a 200 daN nel rispetto della nuova direttiva comunitaria 2014/47/UE per la sicurezza e fissaggio del carico.

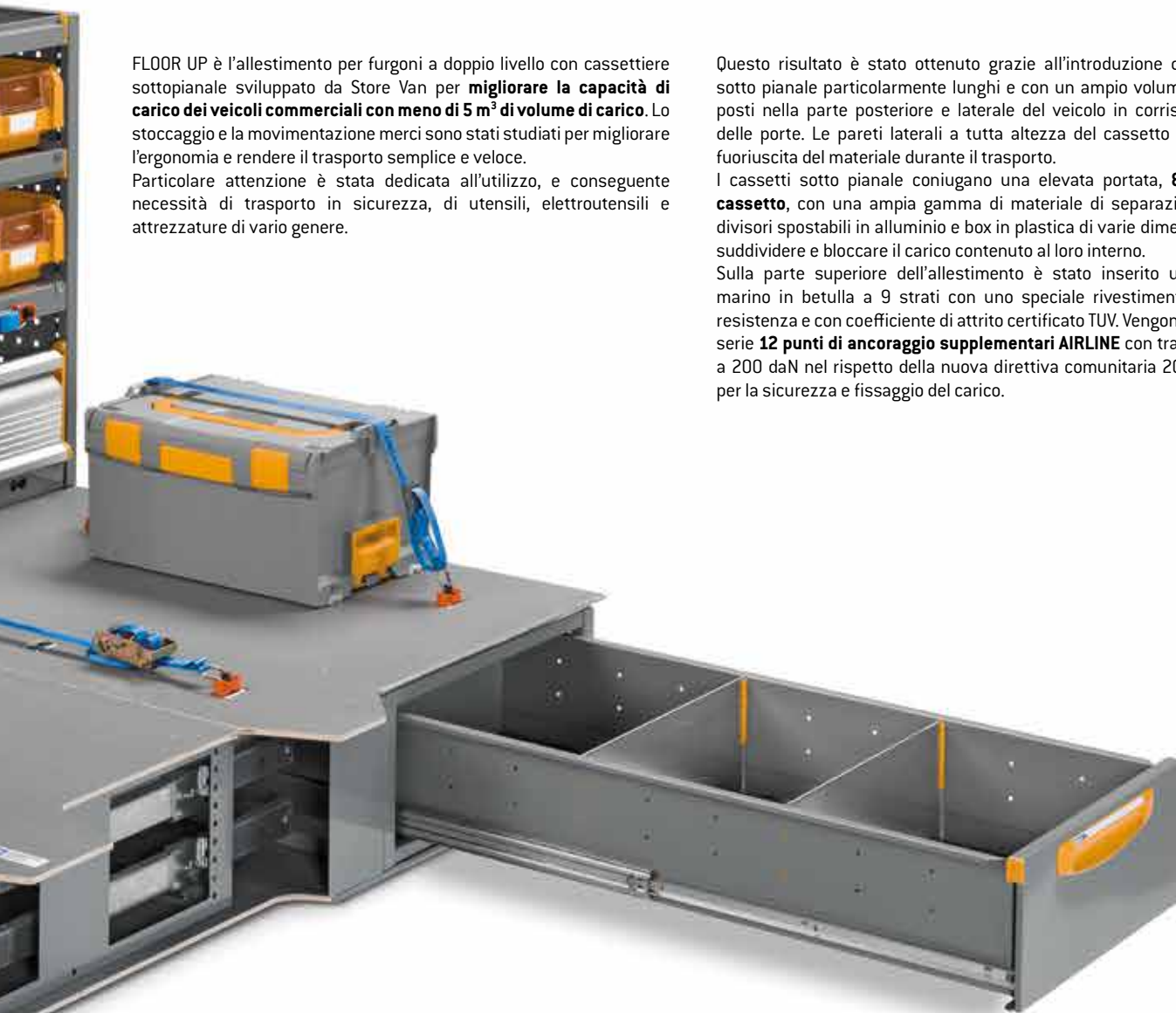

FLOOR UP est l'aménagement pour fourgons à deux niveaux avec blocs-tiroirs sous le plancher développé par Store Van pour **améliorer la capacité de chargement des véhicules utilitaires disposant de moins de 5 m³ de volume de chargement**. Le stockage et la manutention des marchandises ont été étudiés pour améliorer l'ergonomie et rendre le transport simple et rapide. La plus grande attention a été accordée à l'utilisation, et donc aux exigences de transport en toute sécurité, d'outils, d'outillages électriques et d'équipements de différents types. Ce résultat a été obtenu grâce à l'installation sous le plancher de tiroirs particulièrement longs et disposant d'un vaste volume intérieur, placés à l'arrière et sur les côtés du véhicule au niveau des portes. Les parois latérales sur toute la hauteur du tiroir évitent la chute du matériel durant le transport. **Les tiroirs sous le plancher présentent**

une capacité de charge élevée, 80 kg par tiroir, et disposent d'une vaste gamme de matériel de compartimentation, tels que des diviseurs en aluminium déplaçables et des bacs en plastique de différentes dimensions pour diviser et bloquer le matériel contenu dans les tiroirs. Un plancher marin en bouleau à 9 couches, doté d'un revêtement spécial haute résistance et d'un coefficient de frottement certifié TÜV, a été installé sur la partie supérieure de l'aménagement. **12 points d'arrimage supplémentaires AIRLINE**, présentant une traction de 200 daN, conformes à la nouvelle directive européenne 2014/47/UE pour la sécurité et la fixation du chargement, sont fournis de série.

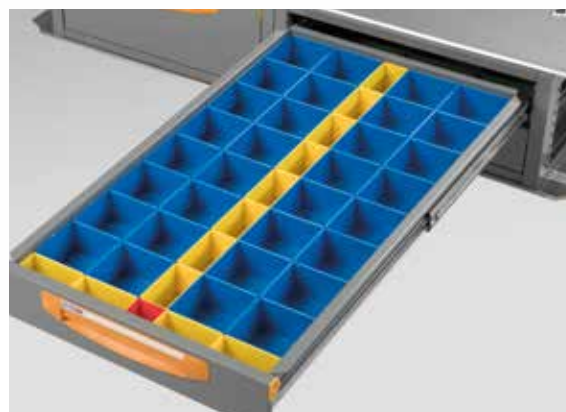

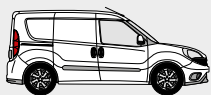

L1 H1

FIAT DOBLÒ
FURGONE LAMIERATO - FOURGON TÔLÉ

FLOOR UP 250

ESEMPI DI ALLESTIMENTO - EXEMPLES D'AMÉNAGEMENTS

PIANALE H 250 mm – PLANCHER H 250 mm

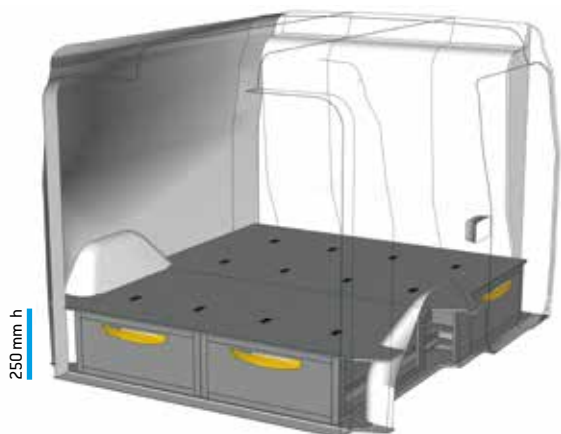

ESEMPIO - EXEMPLE

DO 0250 01*

L=1580 P=1489 H=269 mm
(solo per paratia in lamiera / seulement pour cloison en tôle)



ESEMPIO - EXEMPLE

DO 0250 02*

L=1580 P=1489 H=269 mm
(solo per paratia in lamiera / seulement pour cloison en tôle)



ESEMPIO - EXEMPLE

DO 0250 03*

L=1580 P=1489 H=269 mm
(solo per paratia in lamiera / seulement pour cloison en tôle)

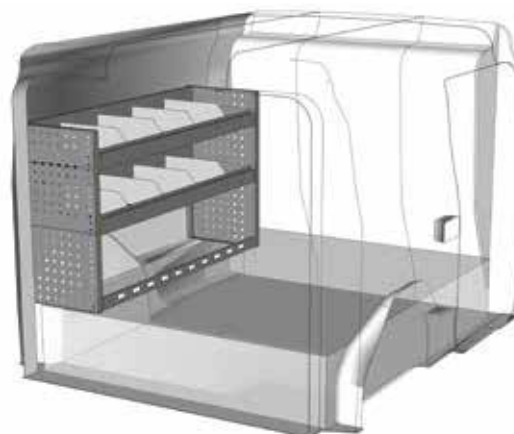

ESEMPIO - EXEMPLE

DO 1207 01*

L=1225 P=365 H=700 mm

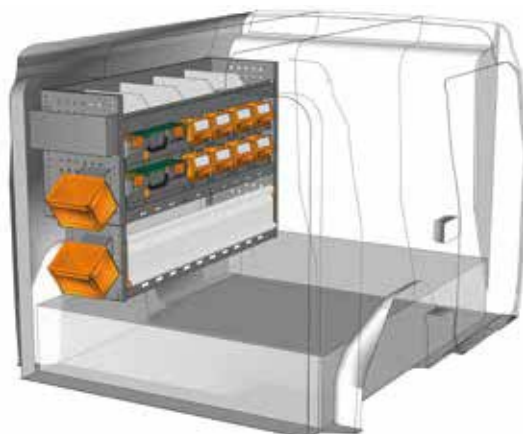
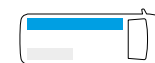

ESEMPIO - EXEMPLE

DO 1208 01*

L=1225 P=365 H=800 mm

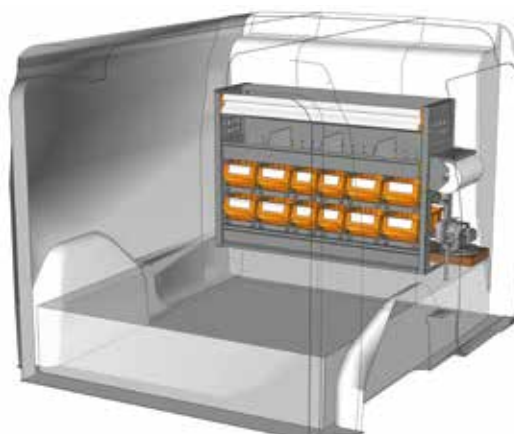
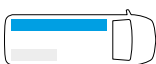

ESEMPIO - EXEMPLE

DO 1007 01*

L=1016 P=265 H=700 mm

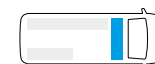

* Kit fissaggio incluso - Jeu de fixation inclus

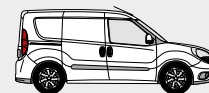

PIANALE H 250 mm – PLANCHER H 250 mm

ESEMPI DI ALLESTIMENTO - EXEMPLES D'AMÉNAGEMENTS

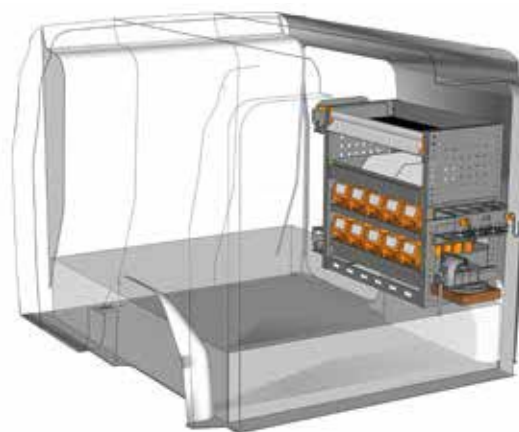
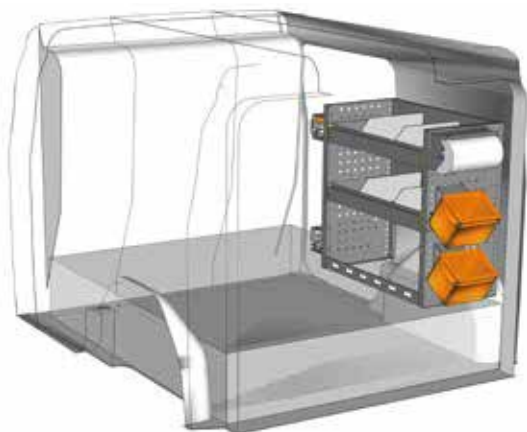

ESEMPIO - EXEMPLE

DO 0707 01*

L=717 P=365 H=700 mm

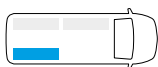

ESEMPIO - EXEMPLE

DO 0707 02*

L=717 P=365 H=700 mm

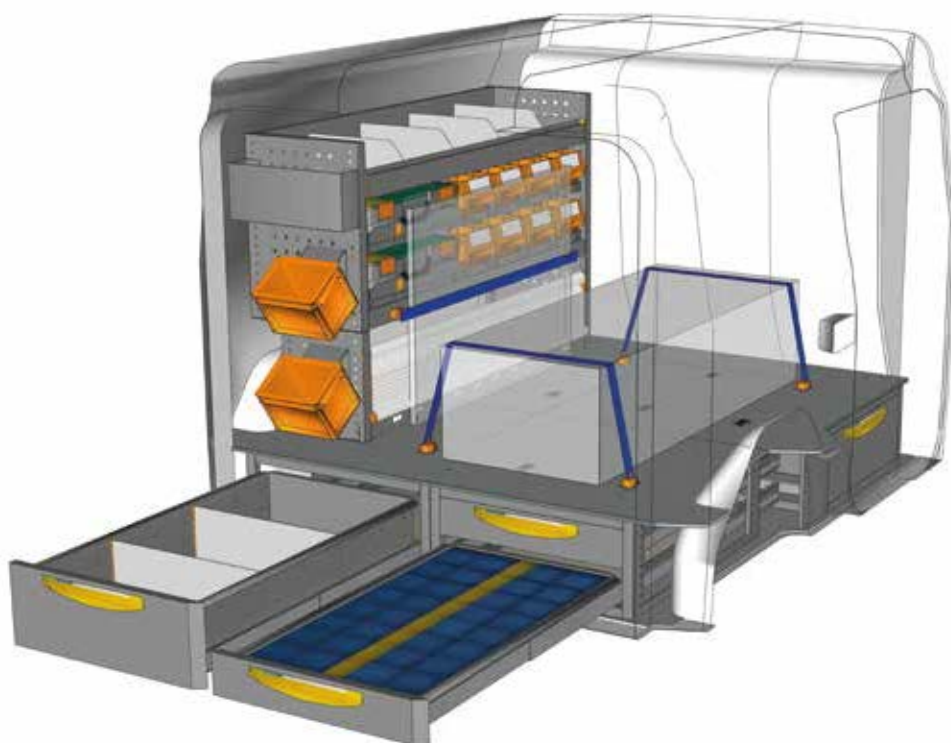
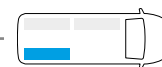

ESEMPIO - EXEMPLE

EXAMPLE DO L1H1 F1*

- 1 x DO 0250 02
- 1 x DO 1208 01
- 1 x E8 093058 B4
- 1 x E8 093058 D0
- 1 x E8 093058 F0
- 1 x E8 108058 C4
- 3 x V 22136



vedi pag. 10/11
voir page 10/11

* Kit fissaggio incluso - Jeu de fixation inclus

Non hai trovato il tuo allestimento?
Affidati ai nostri professionisti
Guarda il retro di questo catalogo e
contatta il punto Store Van piu vicino
oppure visita il nostro sito.

**Vous n'avez pas trouvé votre
équipement ? Confiez-vous
à nos professionnels**
Voir au dos de ce catalogue
et contactez le point StoreVan
le plus proche ou visitez notre site web.

FURGONE LAMIERATO - FOURGON TÔLE

FIAT DOBLÒ
FLOOR UP 250



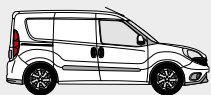

L1 H1

FIAT DOBLÒ
FURGONE LAMIERATO - FOURGON TÔLÉ

FLOOR UP 350

ESEMPI DI ALLESTIMENTO - EXEMPLES D'AMÉNAGEMENTS

PIANALE H 350 mm - PLANCHER H 350 mm



350 mm h

ESEMPIO - EXEMPLE

DO 0350 01*

L=1540 P=1489 H=369 mm
(solo per paratia in lamiera / seulement pour cloison en tôle)



350 mm h

ESEMPIO - EXEMPLE

DO 0350 02*

L=1540 P=1489 H=369 mm
(solo per paratia in lamiera / seulement pour cloison en tôle)

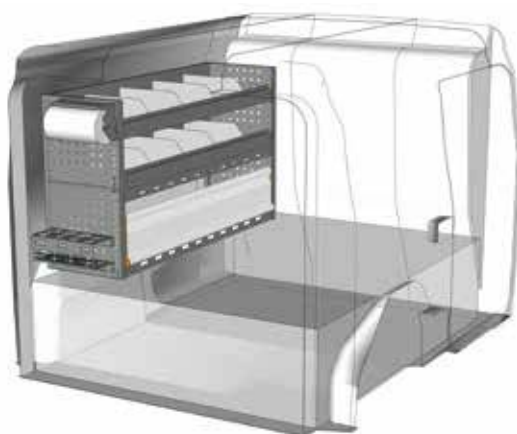

ESEMPIO - EXEMPLE

DO 1207 11*

L=1225 P=365 H=700 mm

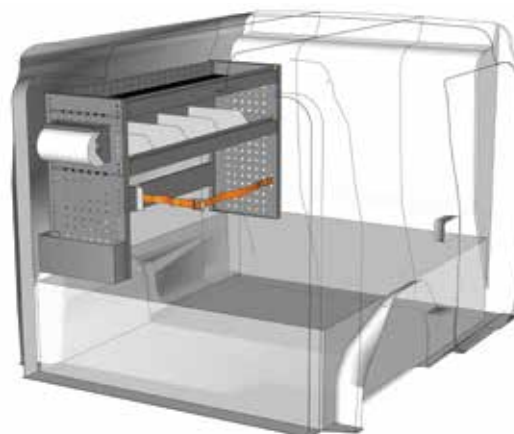

ESEMPIO - EXEMPLE

DO 1207 12*

L=1225 P=365 H=700 mm

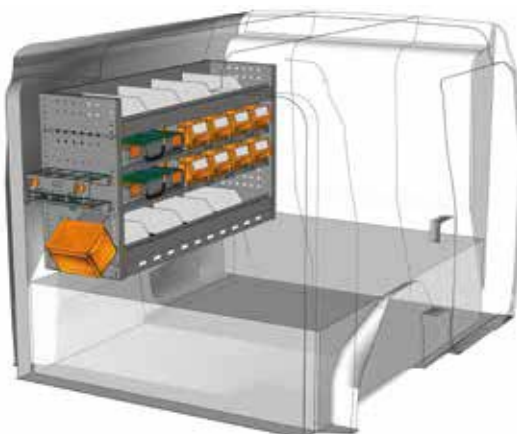
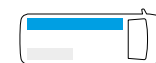

ESEMPIO - EXEMPLE

DO 1207 13*

L=1225 P=365 H=700 mm

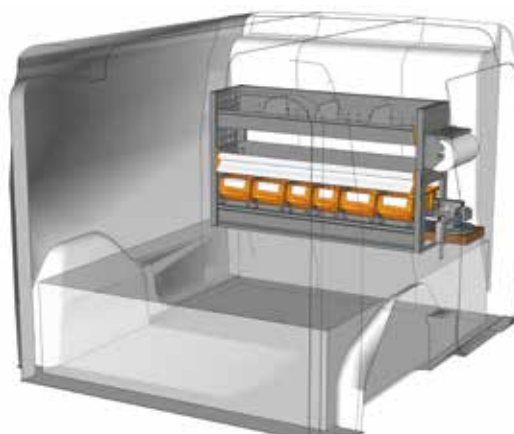

ESEMPIO - EXEMPLE

DO 1006 01*

L=1016 P=265 H=600 mm

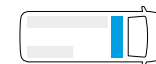

* Kit fissaggio incluso - Jeu de fixation inclus

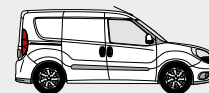

PIANALE H 350 mm – PLANCHER H 350 mm

ESEMPI DI ALLESTIMENTO - EXEMPLES D'AMÉNAGEMENTS

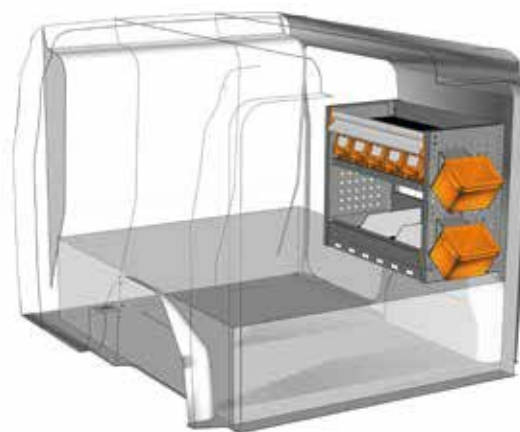
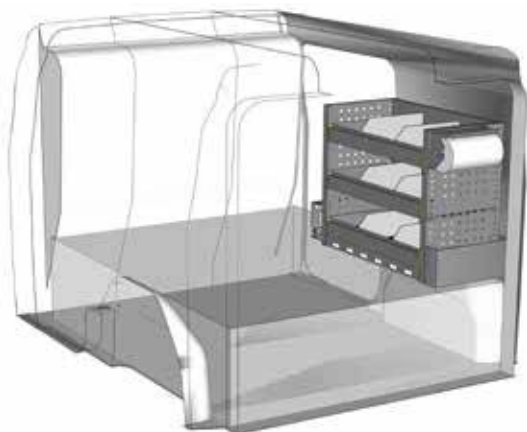

ESEMPIO - EXEMPLE

DO 0706 01*

L=717 P=365 H=600 mm

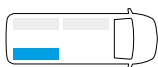

ESEMPIO - EXEMPLE

DO 0706 03*

L=717 P=365 H=600 mm

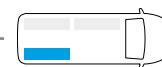

FURGONE LAMIERATO - FOURGON TÔLE
FIAT DOBLÒ

FLOOR UP 350

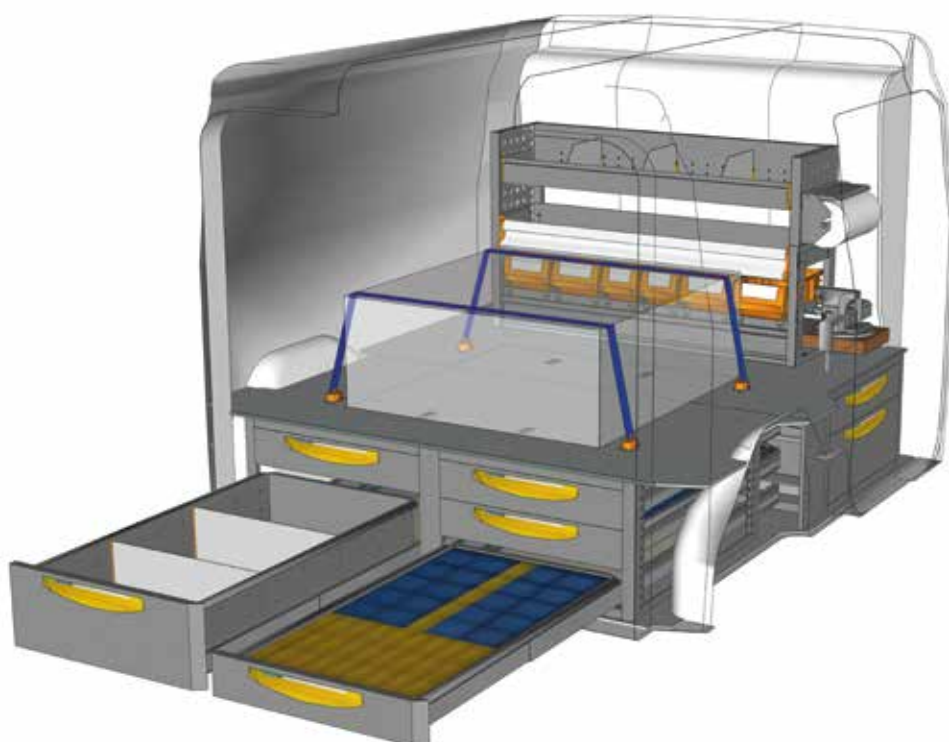

ESEMPIO - EXEMPLE

EXAMPLE DO L1H1 F2*

- 1 x DO 0350 02
- 1 x DO 1006 01
- 1 x E8 093058 B1
- 1 x E8 093058 B4
- 1 x E8 093058 F0
- 1 x E8 093058 D0
- 1 x E8 093058 E0
- 1 x E8 093058 H0

- 1 x E8 108058 C4
- 2 x V 22136



vedi pag. 10/11
voir page 10/11

* Kit fissaggio incluso - Jeu de fixation inclus

Non hai trovato il tuo allestimento?

Affidati ai nostri professionisti

Guarda il retro di questo catalogo e
contatta il punto Store Van piu vicino
oppure visita il nostro sito.

**Vous n'avez pas trouvé votre
équipement ? Confiez-vous
à nos professionnels**

Voir au dos de ce catalogue
et contactez le point StoreVan
le plus proche ou visitez notre site web.



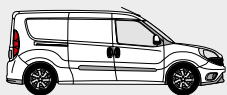

L2 H1

FIAT DOBLÒ
FURGONE LAMIERATO - FOURGON TÔLE

FLOOR UP 250

ESEMPI DI ALLESTIMENTO - EXEMPLES D'AMÉNAGEMENTS

PIANALE H 250 mm – PLANCHER H 250 mm



ESEMPIO - EXEMPLE

DO 0250 21*

L=1930 P=1489 H=269 mm
(solo per paratia in lamiera / seulement pour cloison en tôle)



ESEMPIO - EXEMPLE

DO 0250 22*

L=1930 P=1489 H=269 mm
(solo per paratia in lamiera / seulement pour cloison en tôle)

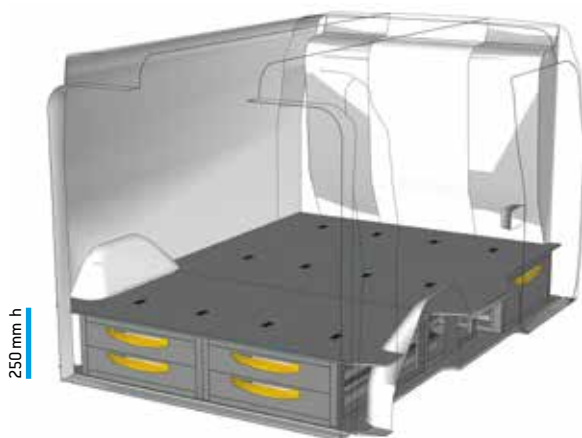

ESEMPIO - EXEMPLE

DO 0250 23*

L=1930 P=1489 H=269 mm
(solo per paratia in lamiera / seulement pour cloison en tôle)

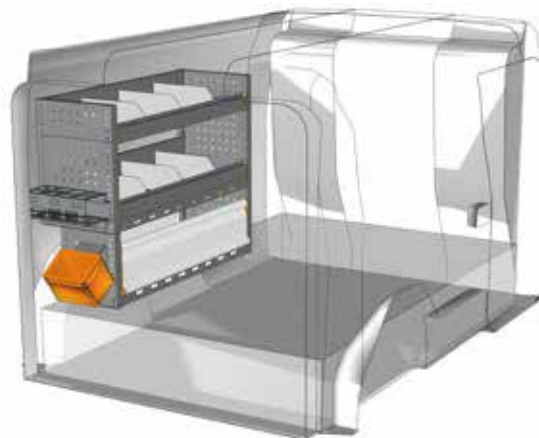

ESEMPIO - EXEMPLE

DO 1008 01*

L=1016 P=365 H=800 mm

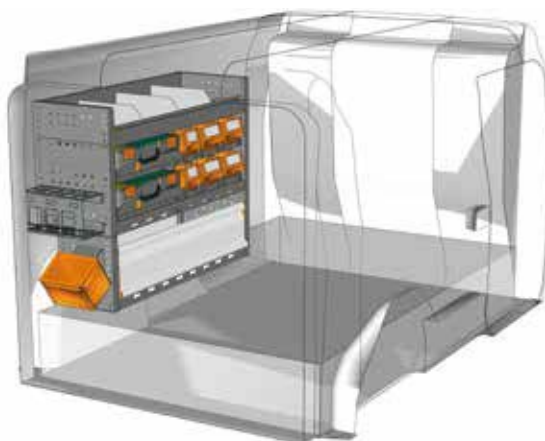
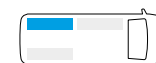

ESEMPIO - EXEMPLE

DO 1008 02*

L=1016 P=365 H=800 mm

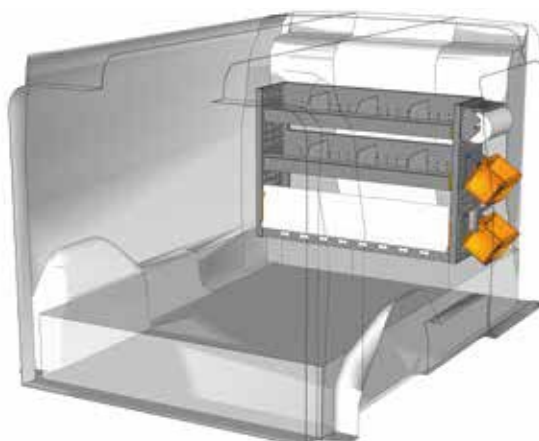
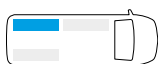

ESEMPIO - EXEMPLE

DO 1007 02*

L=1016 P=265 H=700 mm

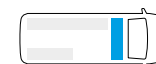

* Kit fissaggio incluso - Jeu de fixation inclus

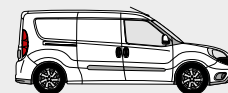

PIANALE H 250 mm – PLANCHER H 250 mm

ESEMPI DI ALLESTIMENTO - EXEMPLES D'AMÉNAGEMENTS

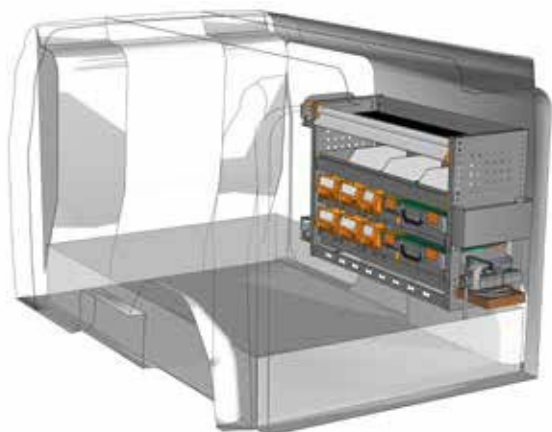

ESEMPIO - EXEMPLE

DO 1007 03*

L=1016 P=365 H=700 mm

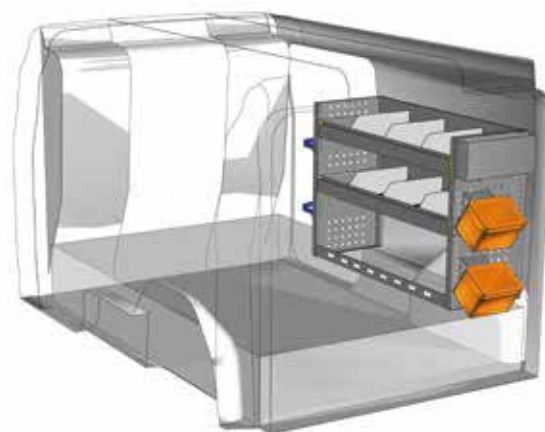
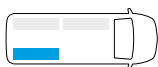

ESEMPIO - EXEMPLE

DO 1007 04*

L=1016 P=365 H=700 mm

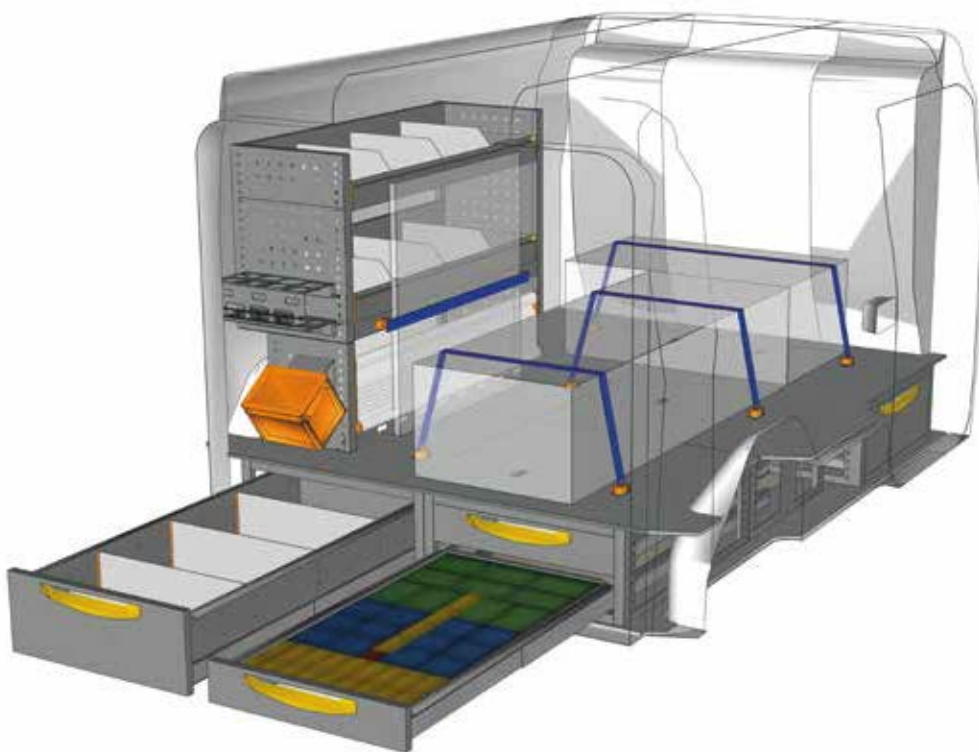
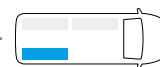

ESEMPIO - EXEMPLE

EXAMPLE DO L2H1 F1*

- 1 x DO 0250 22
- 1 x DO 1008 01
- 2 x E8 108058 C4
- 1 x E8 093058 H0
- 1 x E8 093058 L0
- 4 x V22136



vedi pag. 10/11
voir page 10/11

* Kit fissaggio incluso - Jeu de fixation inclus

FURGONE LAMIERATO - FOURGON TÔLE
FIAT DOBLÒ

FLOOR UP 250

Non hai trovato il tuo allestimento?
Affidati ai nostri professionisti
Guarda il retro di questo catalogo e
contatta il punto Store Van più vicino
oppure visita il nostro sito.

**Vous n'avez pas trouvé votre
équipement ? Confiez-vous
à nos professionnels**
Voir au dos de ce catalogue
et contactez le point StoreVan
le plus proche ou visitez notre site web.



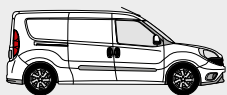

L2 H1

FIAT DOBLÒ
FURGONE LAMIERATO - FOURGON TÔLE

FLOOR UP 350

ESEMPI DI ALLESTIMENTO - EXEMPLES D'AMÉNAGEMENTS

PIANALE H 350 mm - PLANCHER H 350 mm



ESEMPIO - EXEMPLE

DO 0350 21*

L=1889 P=1489 H=369 mm
(solo per paratia in lamiera / seulement pour cloison en tôle)

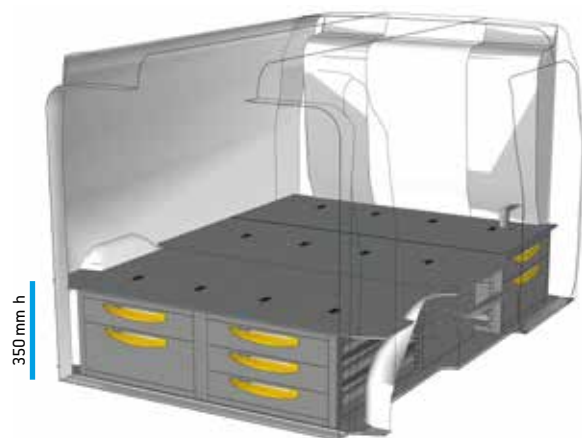

ESEMPIO - EXEMPLE

DO 0350 22*

L=1889 P=1489 H=369 mm
(solo per paratia in lamiera / seulement pour cloison en tôle)

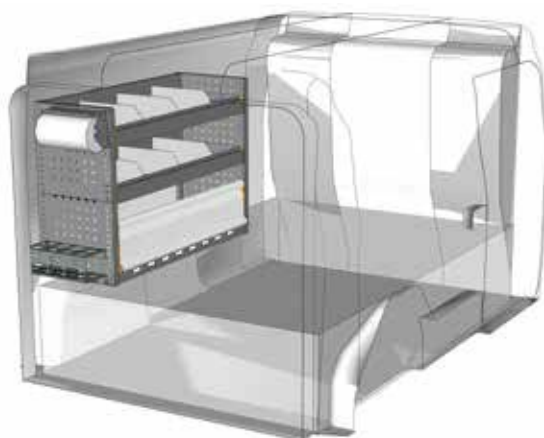

ESEMPIO - EXEMPLE

DO 1007 05*

L=1016 P=365 H=700 mm

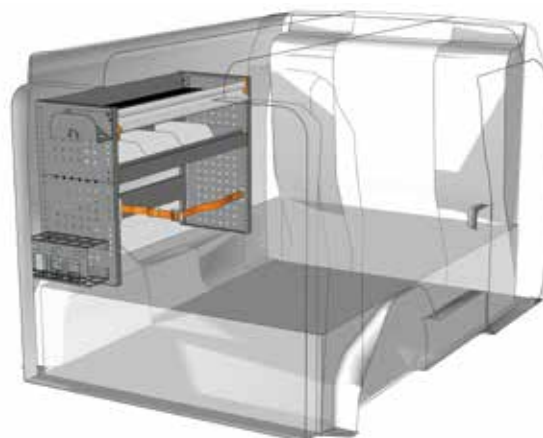
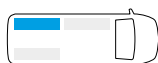

ESEMPIO - EXEMPLE

DO 1007 06*

L=1016 P=365 H=700 mm

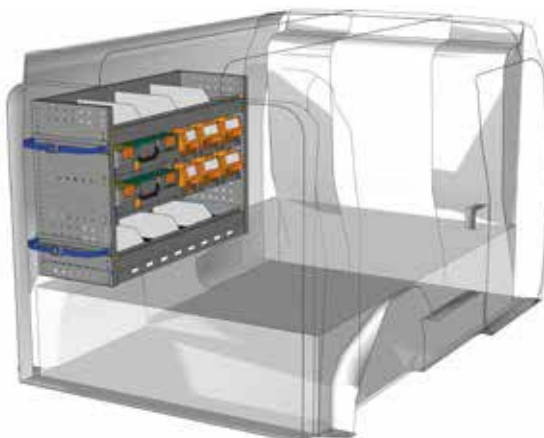
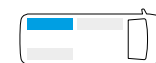

ESEMPIO - EXEMPLE

DO 1007 07*

L=1016 P=365 H=700 mm

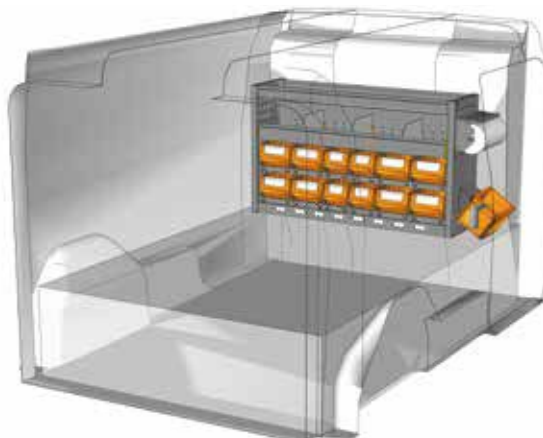
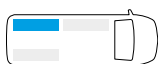

ESEMPIO - EXEMPLE

DO 1006 02*

L=1016 P=265 H=600 mm

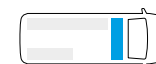

* Kit fissaggio incluso - Jeu de fixation inclus

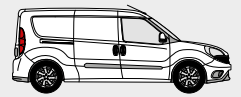

PIANALE H 350 mm – PLANCHER H 350 mm

ESEMPIO DI ALLESTIMENTO - EXEMPLES D'AMÉNAGEMENTS

FURGONE LAMIERATO - FOURGON TÔLE

FLOOR UP 350

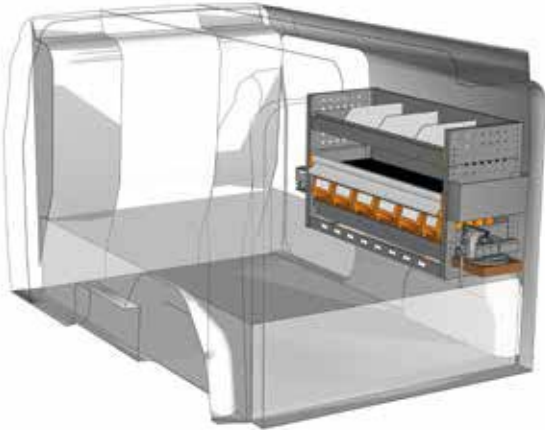

ESEMPIO - EXEMPLE

DO 1006 03*

L=1016 P=365 H=600 mm

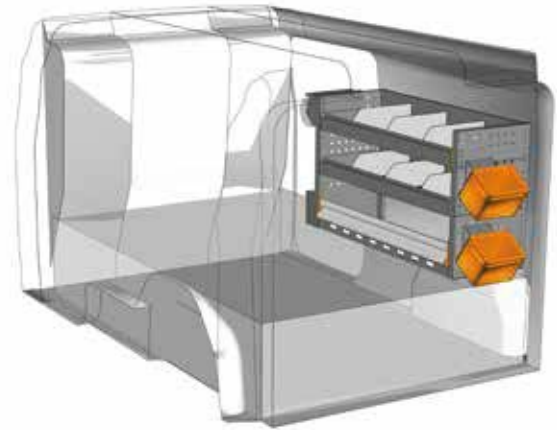
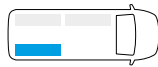

ESEMPIO - EXEMPLE

DO 1006 05*

L=1016 P=365 H=600 mm

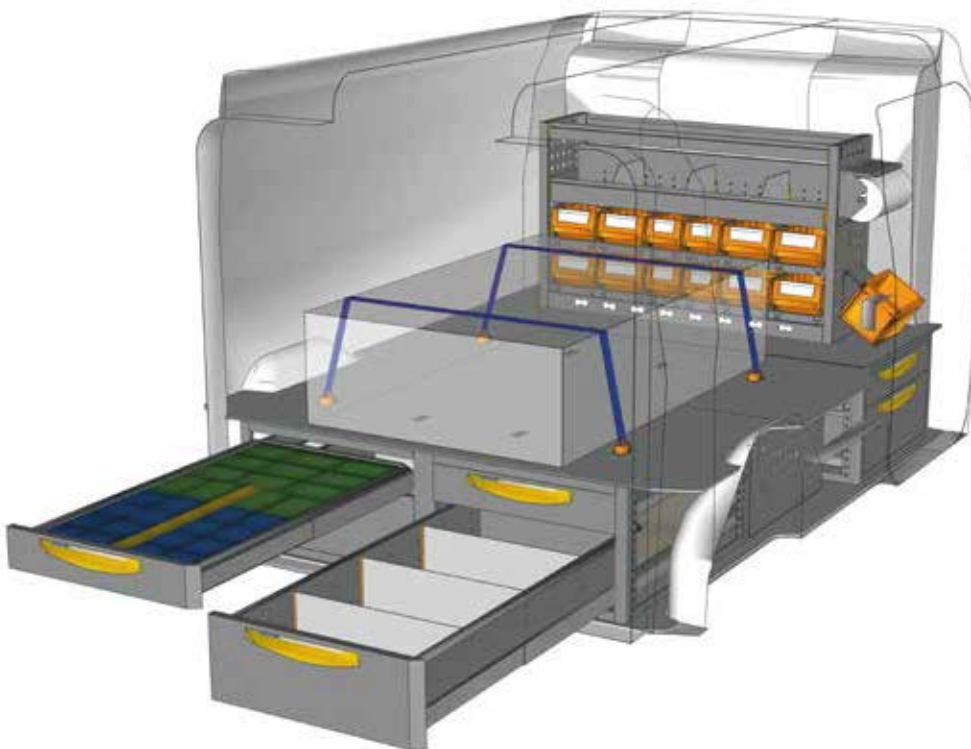
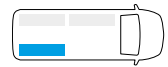

ESEMPIO - EXEMPLE

EXAMPLE DO L2H1 F2*

- 1 x DO 0350 21
- 1 x DO 1006 02
- 1 x E8 093058 G0
- 3 x E8 108058 C4
- 1 x E8 093058 D0
- 1 x E8 093058 E0
- 2 x V22136



vedi pag. 10/11
voir page 10/11

* Kit fissaggio incluso - Jeu de fixation inclus

Non hai trovato il tuo allestimento?

Affidati ai nostri professionisti

Guarda il retro di questo catalogo e
contatta il punto Store Van più vicino
oppure visita il nostro sito.

**Vous n'avez pas trouvé votre
équipement ? Confiez-vous
à nos professionnels**

Voir au dos de ce catalogue
et contactez le point StoreVan
le plus proche ou visitez notre site web.



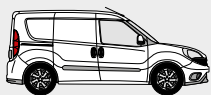

VEICOLO VÉHICULE	PORTATUTTO GALERIE DE TOIT ART.	DIMENSIONI DIMENSIONS	PESO POIDS	PORTATA CHARGE
Modello - Modèle L1 H1	POT 014	2000x1600 mm	23,03 kg	76,00 kg
Modello - Modèle L2 H1	POT 015	2500x1600 mm	24,95 kg	74,00 kg

- Solo per veicolo con porte posteriori a battente.
- Seulement pour véhicule avec portes arrière battantes.

POT

- Portatutto completo di:
 - barre in alluminio complete di attacchi e profilo in gomma
 - sponde laterali in alluminio
 - rullo di caricamento in alluminio
 - viterie di fissaggio fornite in acciaio inox
- Galerie de toit complète de :
 - barres en aluminium avec fixations et profil en caoutchouc
 - rebords latéraux en aluminium
 - rouleau de chargement en aluminium
 - visserie de fixation fournie en acier inox



VEICOLO VÉHICULE	PORTASCALE PORTE-ÉCHELLES ART.	DIMENSIONI DIMENSIONS	PESO POIDS	PORTATA CHARGE
Modello - Modèle L1 H1	POS 016	2110x1580 mm	45,56 kg	54,00 kg
Modello - Modèle L2 H1	POS 017	2650x1580 mm	49,72 kg	50,00 kg

- Solo per veicolo con porte posteriori a battente.
- La slitta portascale può essere montata a destra o a sinistra.
- Seulement pour véhicule avec portes arrière battantes.
- Le chariot porte-échelles peut être monté à droite ou à gauche.

POS

- Portascale completo di:
 - barre in alluminio complete di attacchi e profilo in gomma
 - sponda laterale in alluminio
 - rullo di caricamento in alluminio
 - slitta portascale in alluminio e acciaio inox
 - viterie di fissaggio fornite in acciaio inox
- Porte-échelles complet de :
 - barres en aluminium avec fixations et profil en caoutchouc
 - rebord latéral en aluminium
 - rouleau de chargement en aluminium
 - chariot porte-échelles en aluminium et acier inox
 - visserie de fixation fournie en acier inox



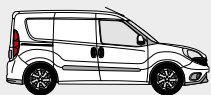

ART. **PAP 265 00**

- Kit porta rotolo con carta Ø 130 mm
- Set support avec rouleau de papier Ø 130 mm

ART. **CAB 220 00**

- Sella reggicavi
- Support pour câbles

ART. **SPR 365 00**

- Porta bombolette P=365 mm
- Porte bombes aérosol P=365 mm

ART. **PAP 365 00**

- Kit porta rotolo con carta Ø 240 mm
- Set support avec rouleau de papier Ø 240 mm

ART. **CAB 296 00**

- Kit sella reggicavi
- Jeu support pour câbles

ART. **SIL 296 00**

- Kit porta silicone - bombolette
- Set porte silicon - bombes aérosols

ART. **AID 265 00**

- Kit pronto soccorso
- Trousse de premier secours

ART. **DOC 365 00**

- Tasca porta documenti A4 - 362x68x209 mm H
- Pochette porte documents A4 - 362x68x209 mm H

ART. **SPR 160 00**

- Kit porta bombolette (2 posti)
- Set port-aérosol a 2 place

ART. **LED 001 00**

- Lampada a led IP20 12V L=600 mm
- Lampe à led IP20 12V L=600 mm

ART. **WAS 365 00**

- Kit lavamani
- Set lavage des mains

ART. **WW MOBILE 1**

- Tavolo con gambe pieghevoli Work Wood - 980x423x802 mm H
- Table avec pieds Pliables - 980x423x802 mm H

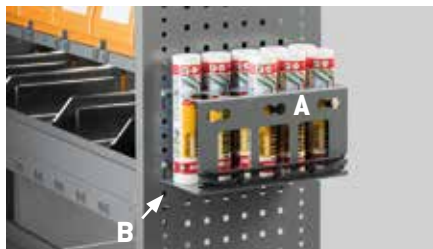
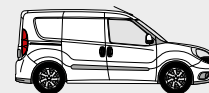

Kit porta silicone
Set porte silicon

A + B

ART. **BAR 296 00** A

- Supporto porta barre filettate / silicone
- Support porte-barres filetées / silicon

ART. **BAR 296 02** B

- Adattatore per cartucce silicone
- Adaptateur pour cartouches silicone

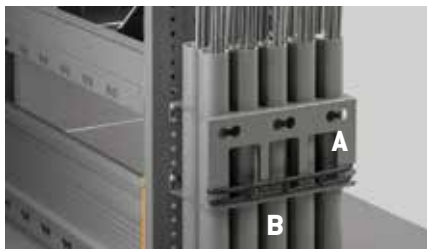

Kit porta barre filettate
Jeu porte-barres filetées

A + B

ART. **BAR 296 00** A

- Supporto porta barre filettate / silicone
- Support porte-barres filetées / silicon

ART. **BAR 296 01** B

- 5 tubi per supporto porta barre filettate
- 5 tuyaux pour porte-barres filetées

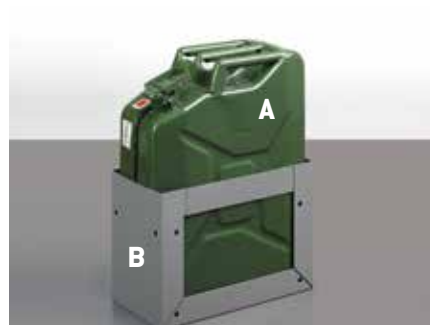

ART. **OIL 20L 00** A

- Tanica in ferro capacità 20 LT
- Bidon en fer 20 LT

ART. **OIL 365 00** B

- Porta tanica
- Porte - bidon

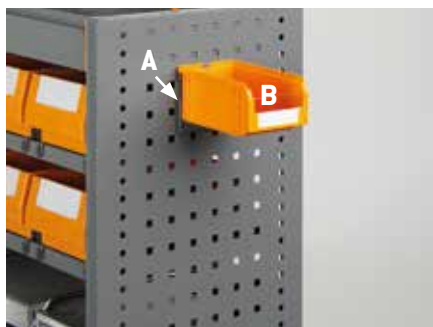

ART. **BL 7433 00** A

- Barra aggancio per 1 contenitore misura 1PL
- Barre porte bac pour 1 bac mesure 1PL

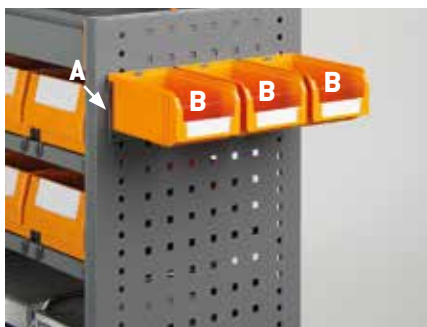

ART. **BL 7434 00** A

- Barra aggancio per 3 contenitori misura 1PL
- Barre porte bac pour 3 bacs mesure 1PL

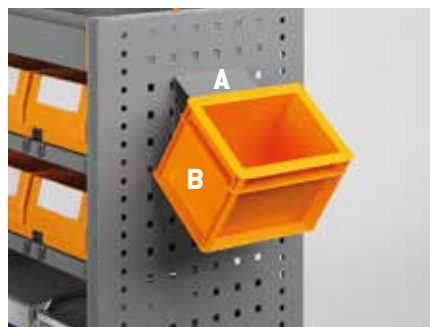

ART. **BL 7432 00** A

- Barra aggancio per 1 contenitore Euro Box
- Barre porte bac pour 1 bac Euro Box

ART. **PM 1751 00** B

- Contenitore in polipropilene misura 1PL
- Bac en polypropylène mesure 1PL

ART. **PM 1751 00** B

- Contenitore in polipropilene misura 1PL
- Bac en polypropylène mesure 1PL

ART. **PA 2251 A0** B

- Cassetta in polipropilene serie Euro Box
- Caisse en polypropylène série Euro Box



ART. **MAG 020**

- Kit 10 calamite Ø 20 mm
- Set de 10 aimants Ø 20mm



ART. **RUB 160 00**

- Tasca porta tappetini - 158x50x171 mm H
- Poche métallique port-tapis antidérapantes - 158x50x171 mm H



ESEMPIO DI UTILIZZO TAPPETINI ANTISCIVOLO

I tappetini antiscivolo sono usati per aumentare il coefficiente di attrito fino a μD 0,6 secondo il principio di calcolo DIN EN 12195-1: 2004 e VDI 2700 ff. Procedura di misurazione secondo la direttiva "VDI 2700 - 15".

EXEMPLE D'UTILISATION POUR TAPIS ANTIDÉRAPANTES

Les tapis antidérapants sont utilisés pour augmenter le coefficient de frottement jusqu'à μD 0,6 selon le principe de calcul DIN EN 12195-1: 2004 et VDI 2700 ss. Procédure de mesure selon la directive "VDI 2700 - 15".

ART. **MAG 025**

- Kit 10 calamite Ø 25 mm
- Set de 10 aimants Ø 25mm

ART. **RUB 000 00**

- Set 6 tappetini antiscivolo - 150x150x3 mm H
- Set des 6 tapis antidérapantes - 150x150x3 mm H

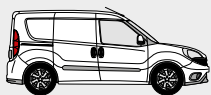

ART. **FIR 000** **A**

- Kit porta bombole
- Set support pour bouteilles de gaz



ART. **FIR 4KG** **B**

- Estintore polvere 4 KG
- Extincteur (poudre) 4 KG



ART. **V18029 03** **A**

- Barra orizzontale fermacarico attacco foro medium L=365 mm
- Barre horizontale d'arrimage fixations trou medium L=365 mm



ART. **V18029 04** **A**

- Barra orizzontale fermacarico attacco foro medium L=445 mm
- Barre horizontale d'arrimage fixations trou medium L=445 mm



ART. **V22868** **B**

- Cinghia fermacarico con cricchetto attacco innesto medium
- Sangle d'arrimage à cliquet pour fixations medium



ART. **V18029 03** **A**

- Barra orizzontale fermacarico attacco foro medium L=365 mm
- Barre horizontale d'arrimage fixations trou medium L=365 mm

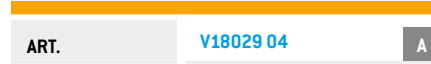

ART. **V18029 04** **A**

- Barra orizzontale fermacarico attacco foro medium L=445 mm
- Barre horizontale d'arrimage fixations trou medium L=445 mm



ART. **V22869** **B**

- Cinghia fermacarico con morsetto attacco innesto medium
- Sangle d'arrimage avec serrage pour fixations medium



Esempio con
2 ART. FIR 000
Exemple avec
2 ART. FIR 000



Esempio con
2 ART. V18029 03
2 ART. V22868
Exemple avec
2 ART. V18029 03
2 ART. V22868



Esempio con
2 ART. V18029 03
2 ART. V22869
Exemple avec
2 ART. V18029 03
2 ART. V22869

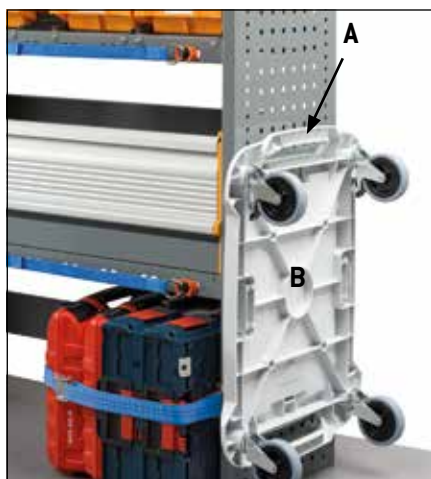
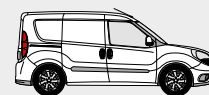

ART.

00 ROLL SU

A

- Kit supporti per STORE BOX ROLL
- Kit de supports pour STORE BOX ROLL

ART.

00 ROLL 00

B

- Carrello con ruote con freni per valigetta BOX 102-136-238-374
- Plateau roulant à frein pour mallette BOX 102-136-238-374



FURGONE LAMIERATO - FOURGON TÔLE
FIAT DOBLÒ



FIAT DOBLÒ

CONDIZIONI DI FORNITURA

- Pianali e pannellature forniti in più pezzi.
- Portatutto e portascale vengono forniti **smontati**.
- I moduli vengono forniti **preassemblati** completi del materiale di ancoraggio al veicolo.
- Per l'installazione dei prodotti si consiglia di rivolgersi alla nostra rete di **installatori autorizzati**.
- I prodotti vengono forniti completi di **imballo**.
- **3 anni di garanzia** sui nostri prodotti.
- Le portate si riferiscono a **peso uniformemente distribuito**.

CONDITIONS DE FOURNITURE

- Planchers et habillages fournis en plusieurs éléments.
- Galeries de toit et porte-échelles sont fournis **démontés**.
- Les modules sont fournis **pré-montés**, avec le matériel de fixation au véhicule.
- Pour l'installation des produits, il est conseillé de s'adresser à notre réseau d'**installateurs agréés**.
- Les produits sont fournis **emballés**.
- **3 ans de garantie** sur nos produits.
- Les capacités de charge se réfèrent à **charge uniformément répartie**.



FAMI S.R.L.

VIA STAZIONE ROSSANO, 13 – 36027 ROSÀ (VI) ITALY
TEL +39 0424 585455 R.A. – FAX +39 0424 585482
INFO@FAMISPA.COM – WWW.FAMISPA.COM

INFO@STOREVAN.COM – WWW.STOREVAN.COM

